

HENGQIN OCEAN KINGDOM PARADE CONCEPT DEVELOPMENT DRAWING PACKAGE FINAL DESIGN PACKAGE UPDATE OCTOBER 2012 DELIVERABLE

SHEET INDEX

Sheet Title	Sheet Description
D-100	SHEET INDEX
D-A1-01	FANFARE
D-A1-02	FANFARE
D-A1-03	FANFARE
D-A1-04	FANFARE
D-B1-01	CORAL REEF: LIONFISH
D-B1-02	CORAL REEF: LIONFISH
D-B2-01	CORAL REEF: OCTOPUS
D-B2-02	CORAL REEF: OCTOPUS
D-C1-01	SHIPWRECK PLAYGROUND
D-C1-02	SHIPWRECK PLAYGROUND
D-C1-03	SHIPWRECK PLAYGROUND
D-C1-04	SHIPWRECK PLAYGROUND
D-C2-01	DIVER
D-C2-02	DIVER
D-C2-03	DIVER
D-C2-04	DIVER
D-C3-01	SUBMARINE
D-C3-02	SUBMARINE
D-C4-01	SILLY SHARK
D-C4-02	SILLY SHARK
D-C5-01	LARGE TURTLE
D-C5-02	LARGE TURTLE
D-D1-01	WALRUS
D-D1-02	WALRUS
D-D2-01	POLAR GAMES
D-D2-02	POLAR GAMES
D-E1.1-01	CRAB CONGA LINE: SEA SNAIL
D-E1.1-02	CRAB CONGA LINE: SEA SNAIL
D-E1.2-01	CRAB CONGA LINE: CRAB
D-E1.2-02	CRAB CONGA LINE: CRAB
D-E2-01	CRUSTACEAN CARNIVAL
D-E2-02	CRUSTACEAN CARNIVAL
D-F2-01	THE GREAT WHALE
D-F2-02	THE GREAT WHALE

DESIGN TEAM

OWNER

Zhuhai Chimelong Investment and Development Co., Ltd.
Chimelong Office G1,
Fuxiang Bay, Hengqin New District
Zhuhai 519031, People's Republic of China

**SHOW DESIGNER
THE HETTEMA GROUP**

PHIL HETTEMA
PRINCIPAL
67 Valley St
Pasadena, CA 91105
Phone : 626.683.9876
Fax : 626.683.9117
phetema@thehettemagroup.com



PROJECT:

HENGQIN OCEAN KINGDOM

CLIENT:

Zhuhai Chimelong Investment and Development Co., Ltd.
Chimelong Office G1,
Fuxiang Bay, Hengqin New District
Zhuhai 519031, People's Republic of China

CONSULTANT:

NOTICES:

THESE PARADE DESIGN DOCUMENTS ARE FOR DESIGN INTENT PURPOSE ONLY AND NOT FOR CONSTRUCTION.

ANY PROJECT ARCHITECTURAL DESIGN, ENGINEERING, CONSTRUCTION, COMMISSIONING, AND COMPLIANCE WITH LOCAL LIFE SAFETY AND BUILDING CODES SHALL BE PROVIDED AND PERFORMED BY LOCALLY LICENSED PROFESSIONALS.

THE DATA IN THIS DOCUMENT INCORPORATE PROPRIETARY RIGHTS OF THE HETTEMA GROUP, 67 VALLEY STREET PASADENA, CA 91105. ANY PARTY ACCEPTING THIS DOCUMENT DOES SO IN CONFIDENCE AND AGREES THAT IT SHALL NOT BE DUPLICATED, IN WHOLE OR IN PART, OR BE DISCLOSED TO OTHERS, WITHOUT THE PRIOR WRITTEN CONSENT OF THE HETTEMA GROUP, INC. AND

ZHUHAI CHIMELONG INVESTMENT AND DEVELOPMENT CO., LTD.
CHIMELONG OFFICE G1,
FUXIANG BAY, HENGQIN NEW DISTRICT
ZHUHAI 519031, PEOPLE'S REPUBLIC OF CHINA

FINAL DESIGN PACKAGE UPDATE PROGRESS PLOT

ISSUE DATE	DESCRIPTION
2012/09/10	CONCEPT DEVELOPMENT
11-OCT-2012	CONCEPT DEVELOPMENT

DRAWING TITLE:

**COVER, SHEET INDEX,
PROJECT TEAM, &
NOTES**

SHEET NO.

D-100

**NOT FOR
CONSTRUCTION**

NUMBER	ANIMATION OR EFFECT	DESCRIPTION OF ANIMATION OR EFFECT	QUANTITY
A1-A	ANIMATION	WHALE SHARK – leaping animation – mechanical, cam	1
A1-B	ANIMATION	SYNCHRONIZED ROLLING WAVES (8) – rotating animation – mechanical, cam	8
A1-C	EFFECT	SCENT EFFECT – sea spray scent cannons concealed within float	1
A1-D	EFFECT	BLOW HOLE SPRAY – Dolphin's blow holes blast LN2 smoke	3
A1-E	ANIMATION	DOLPHIN, tethered to chariot – leaping animation – mechanical, cam	2
A1-F	ANIMATION	DOLPHIN, untethered – leaping animation – mechanical, cam	1
A1-G	ANIMATION	SYNCHRONIZED SWIMMING FISH (11 PER SIDE) – leaping animation – mechanical, cam	22

ISSUE DATE	DESCRIPTION
2012/09/10	CONCEPT DESIGN
11-OCT-2012	CONCEPT DEVELOPMENT
-	-
-	-
-	-

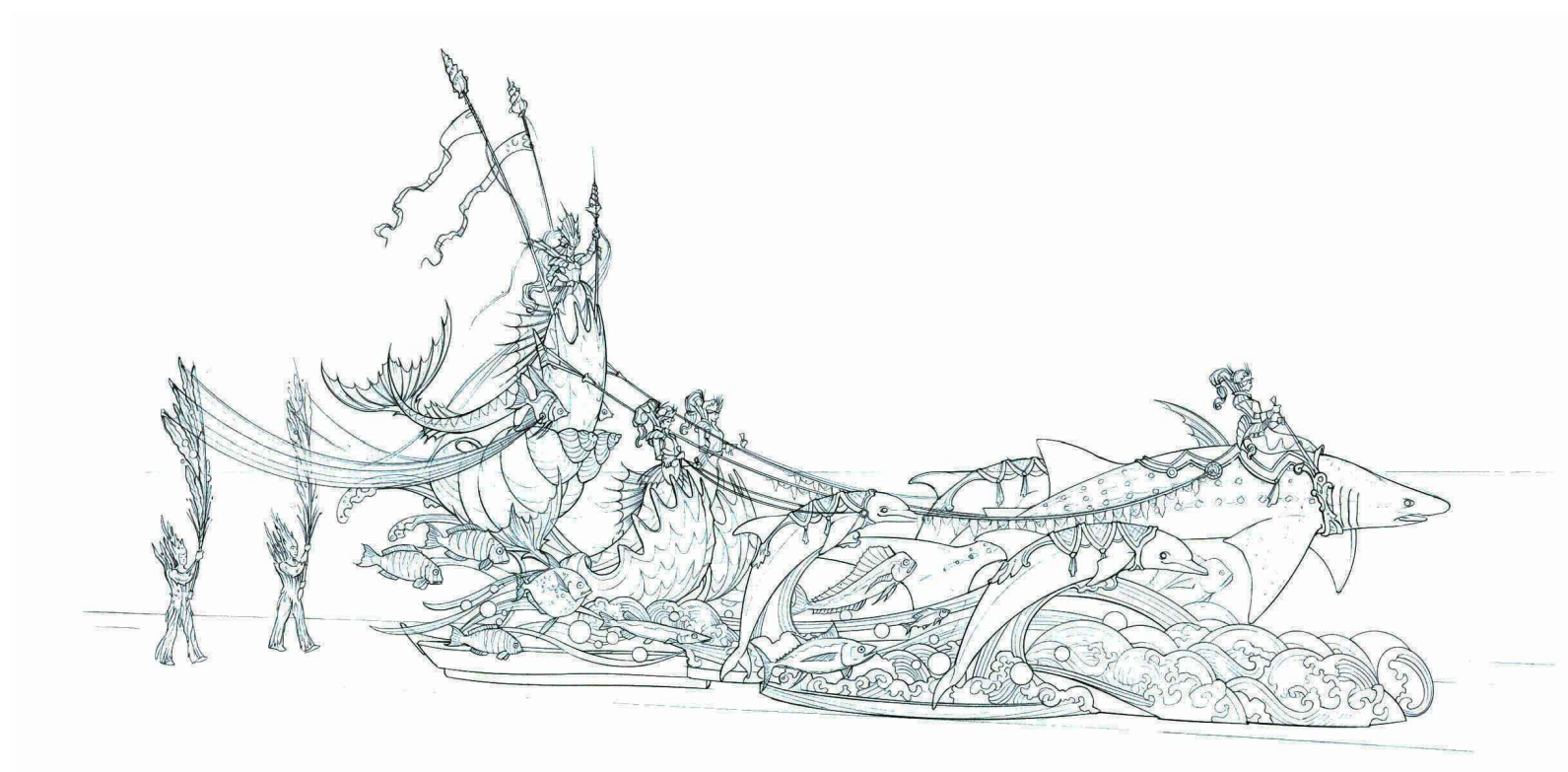

CONCEPT ARTWORK

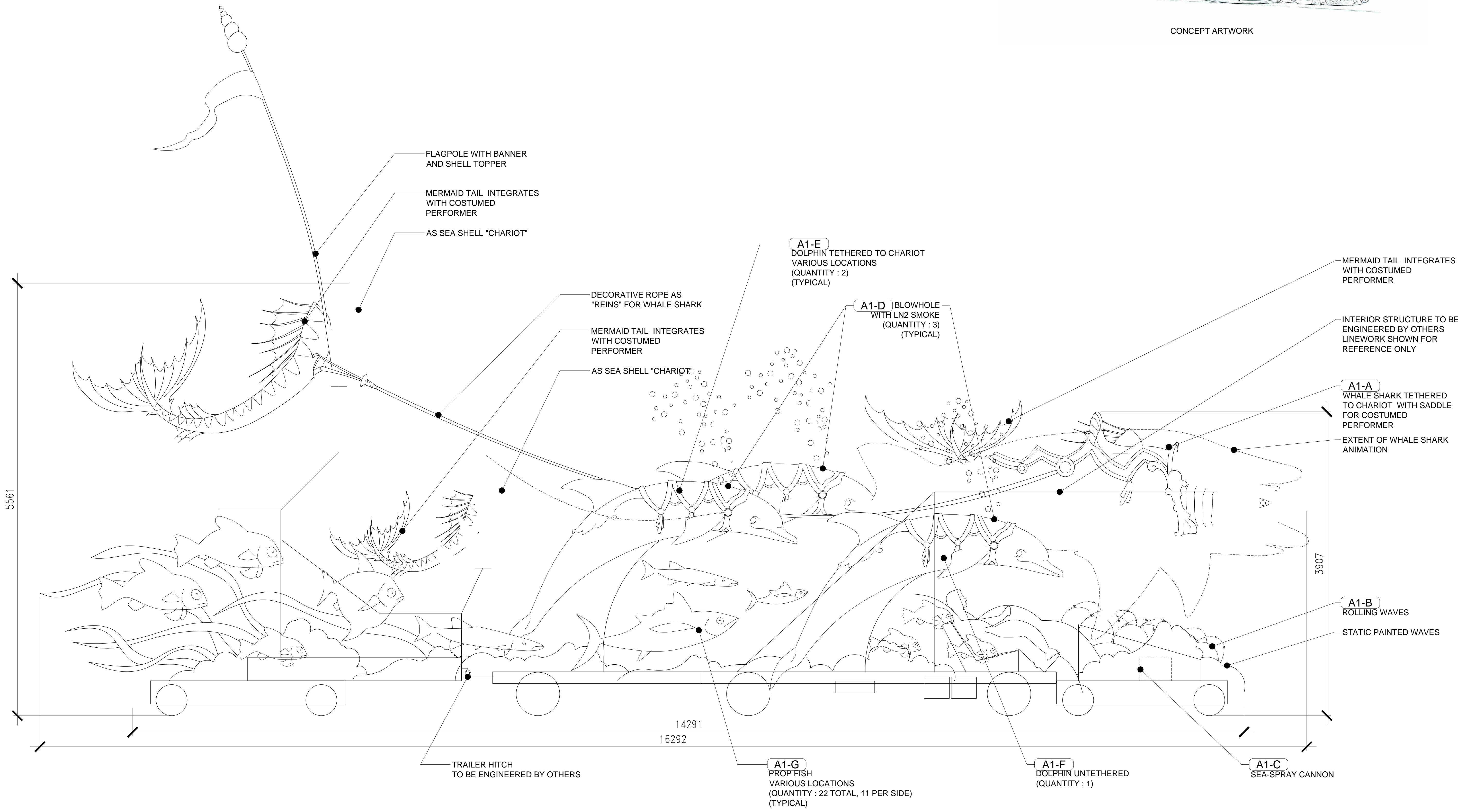

1 CHIMELONG PARADE FANFARE ELEVATION
 1:25

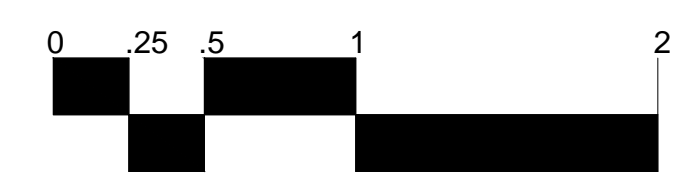

NOT FOR CONSTRUCTION

PROJECT:

HENQIN OCEAN KINGDOM

CLIENT:

Zhuhai Chimelong Investment
 and Development Co., Ltd.
 Chimelong Office G1,
 Fuxiang Bay, Hengqin New
 District
 Zhuhai 519031, People's
 Republic of China

CONSULTANT:

NOTICES:
 THESE PARADE DESIGN DOCUMENTS ARE FOR DESIGN INTENT PURPOSE ONLY AND NOT FOR CONSTRUCTION.

ANY PROJECT ARCHITECTURAL DESIGN, ENGINEERING, CONSTRUCTION, COMMISSIONING, AND COMPLIANCE WITH LOCAL LIFE SAFETY AND BUILDING CODES SHALL BE PROVIDED AND PERFORMED BY LOCALLY LICENSED PROFESSIONALS.

THE DATA IN THIS DOCUMENT INCORPORATE PROPRIETARY RIGHTS OF THE HETEMA GROUP, 67 VALLEY STREET PASADENA, CA 91105. ANY PARTY ACCEPTING THIS DOCUMENT DOES SO IN CONFIDENCE AND AGREES THAT IT SHALL NOT BE DUPLICATED, IN WHOLE OR IN PART, OR BE DISCLOSED TO OTHERS, WITHOUT THE PRIOR WRITTEN CONSENT OF THE HETEMA GROUP, INC. AND ZHUHAI CHIMELONG INVESTMENT AND DEVELOPMENT CO., LTD. CHIMELONG OFFICE G1, FUXIANG BAY, HENQIN NEW DISTRICT ZHUHAI 519031, PEOPLE'S REPUBLIC OF CHINA

**FINAL DESIGN
 PACKAGE UPDATE
 PROGRESS PLOT**

ISSUE DATE	DESCRIPTION
2012/09/10	CONCEPT DESIGN
11-OCT-2012	CONCEPT DEVELOPMENT
-	-
-	-
-	-

DRAWING TITLE:
**CHIMELONG PARADE
 CONCEPT DEVELOPMENT
 FANFARE**

SHEET NO.

D-A1-02

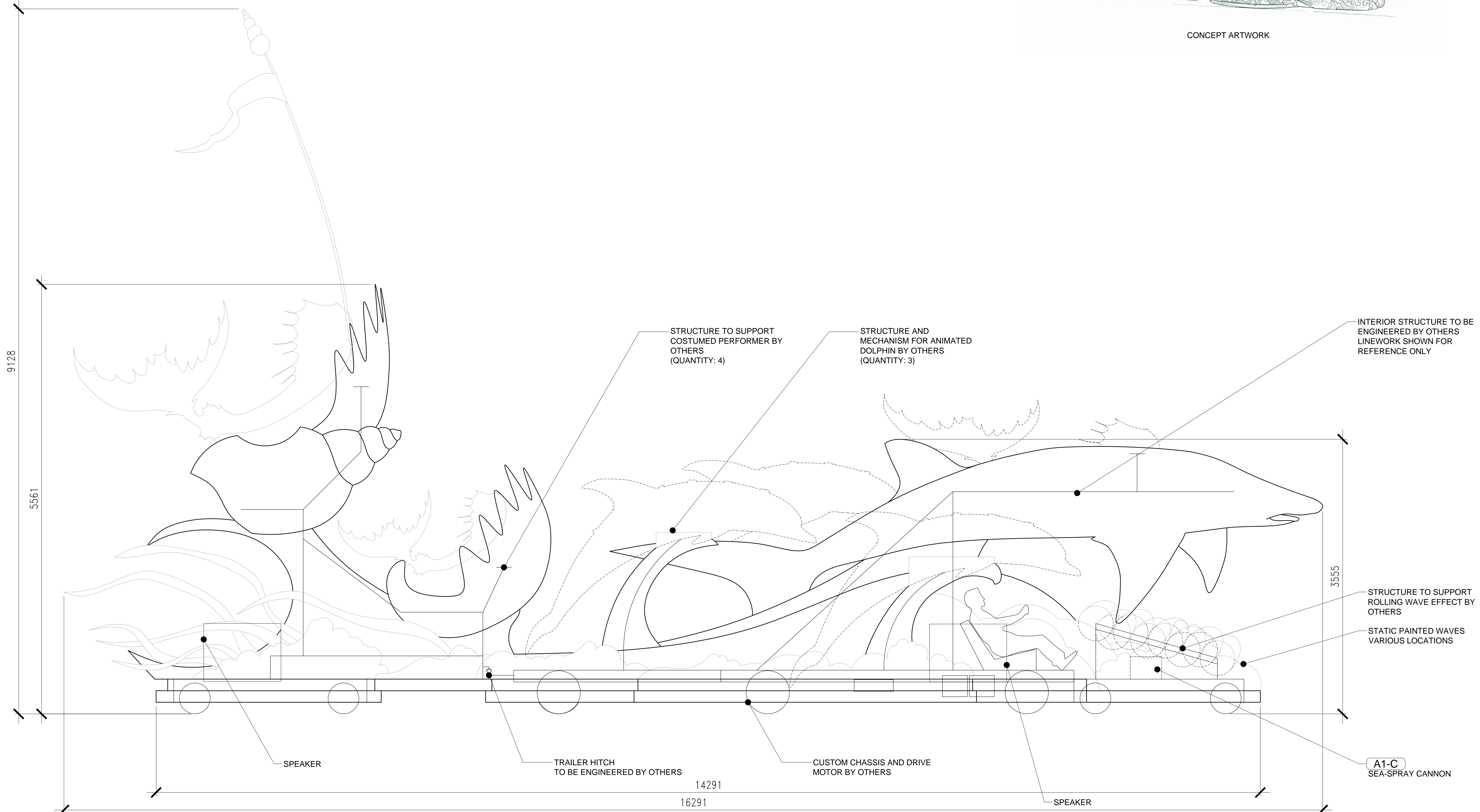
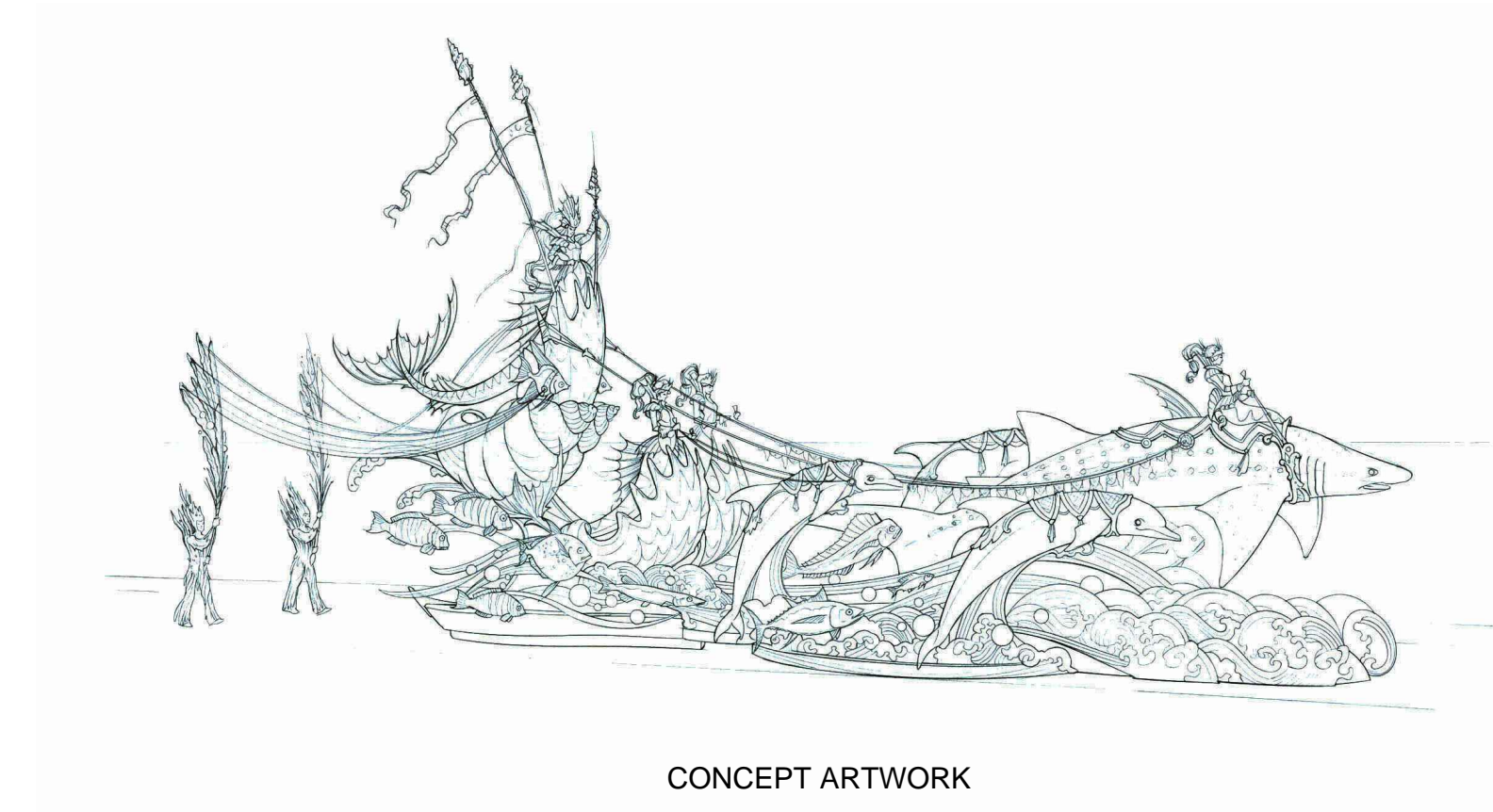

2 CHIMELONG PARADE FANFARE ELEVATION
 1:25

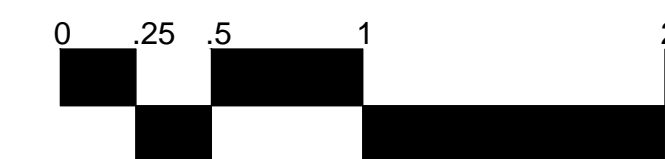

**NOT FOR
CONSTRUCTION**

PROJECT:
HENQIN OCEAN KINGDOM

CLIENT:
Zhuhai Chimelong Investment and Development Co., Ltd.
 Chimelong Office G1,
 Fuxiang Bay, Hengqin New District
 Zhuhai 519031, People's Republic of China

CONSULTANT:

NOTICES:
 THESE PARADE DESIGN DOCUMENTS ARE FOR DESIGN INTENT PURPOSE ONLY AND NOT FOR CONSTRUCTION.

ANY PROJECT ARCHITECTURAL DESIGN, ENGINEERING, CONSTRUCTION, COMMISSIONING, AND COMPLIANCE WITH LOCAL LIFE SAFETY AND BUILDING CODES SHALL BE PROVIDED AND PERFORMED BY LOCALLY LICENSED PROFESSIONALS.

THE DATA IN THIS DOCUMENT INCORPORATE PROPRIETARY RIGHTS OF THE HETEMA GROUP, 67 VALLEY STREET PASADENA, CA 91105. ANY PARTY ACCEPTING THIS DOCUMENT DOES SO IN CONFIDENCE AND AGREES THAT IT SHALL NOT BE DUPLICATED, IN WHOLE OR IN PART, OR BE DISCLOSED TO OTHERS, WITHOUT THE PRIOR WRITTEN CONSENT OF THE HETEMA GROUP, INC. AND ZHUHAI CHIMELONG INVESTMENT AND DEVELOPMENT CO., LTD. CHIMELONG OFFICE G1, FUXIANG BAY, HENQIN NEW DISTRICT ZHUHAI 519031, PEOPLE'S REPUBLIC OF CHINA

FINAL DESIGN PACKAGE UPDATE PROGRESS PLOT

ISSUE DATE	DESCRIPTION
2012/09/10	CONCEPT DESIGN
11-OCT-2012	CONCEPT DEVELOPMENT
-	-
-	-
-	-

DRAWING TITLE:
CHIMELONG PARADE CONCEPT DEVELOPMENT FANFARE

SHEET NO.

D-A1-03

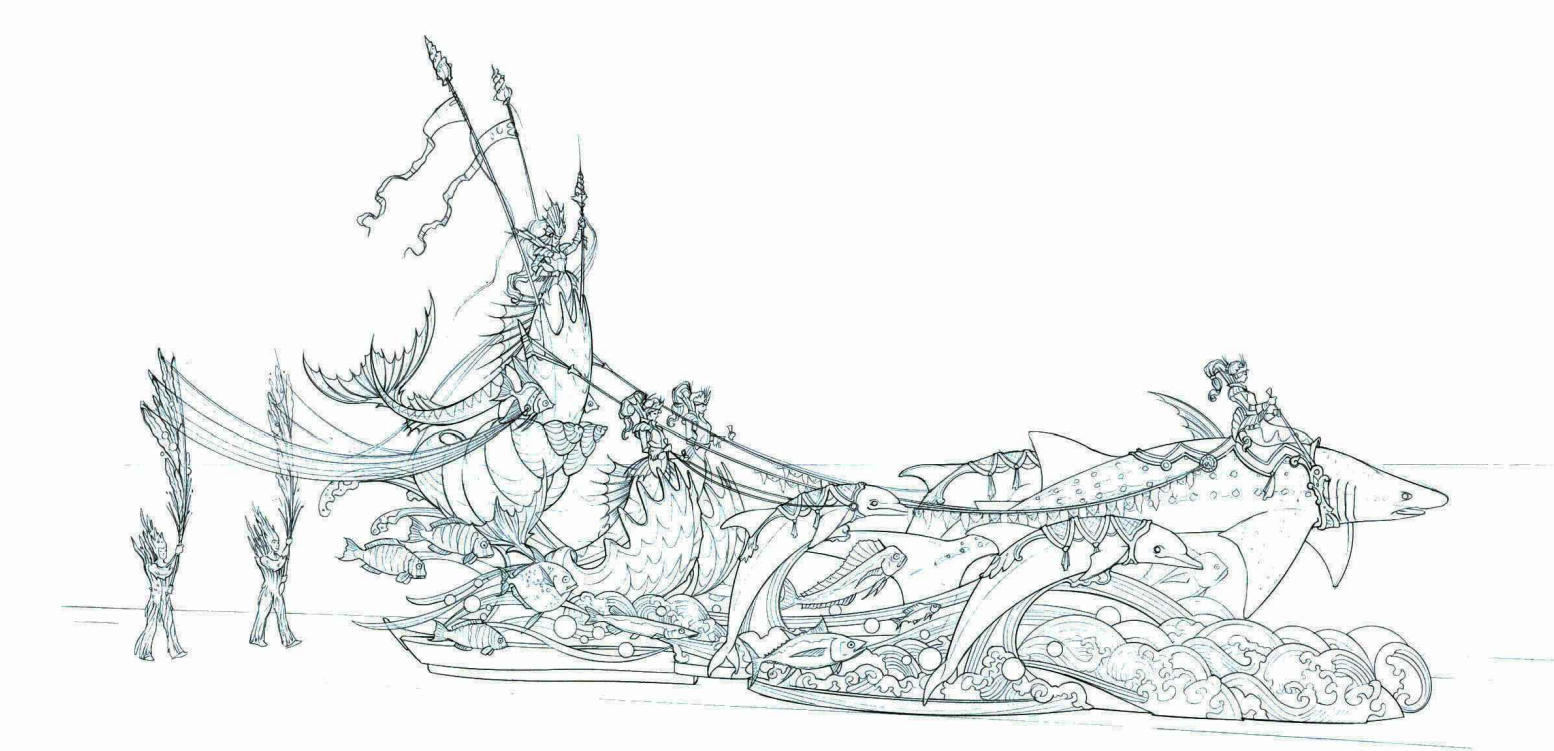

CONCEPT ARTWORK

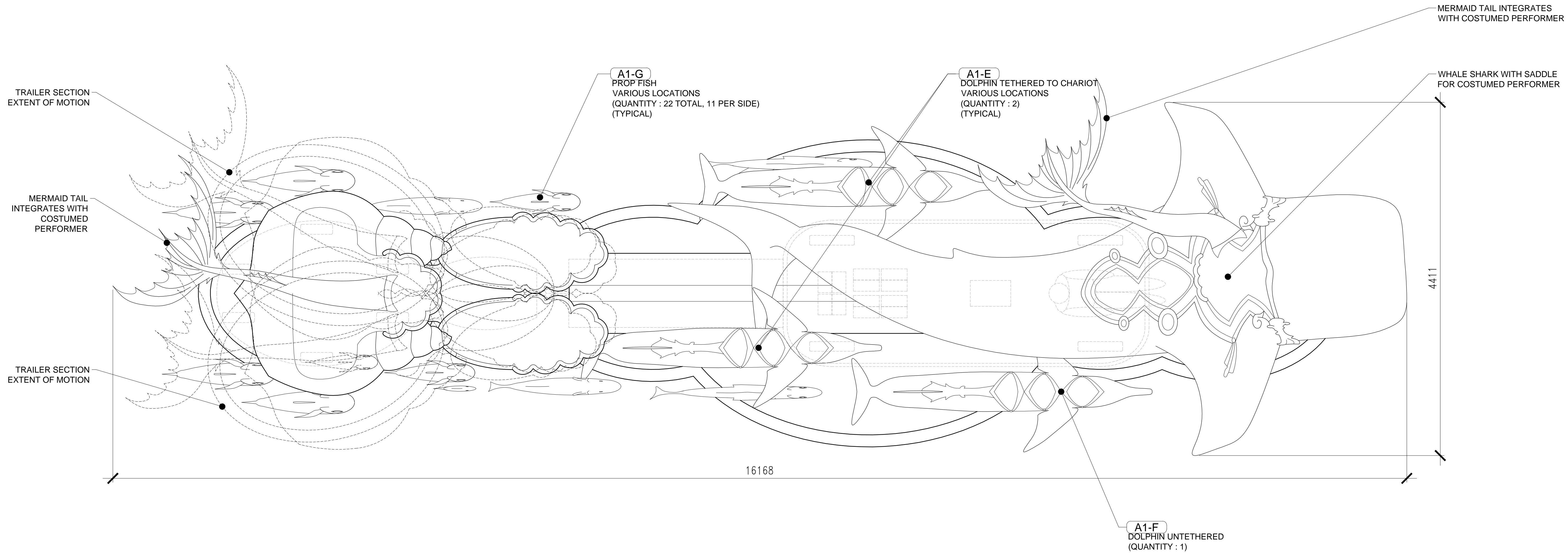

3 CHIMELONG PARADE FANFARE PLAN
 1:25

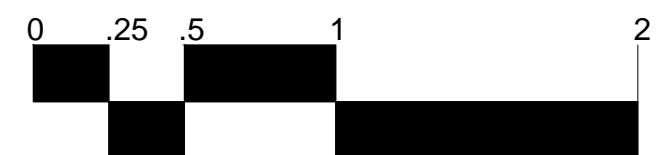

NOT FOR CONSTRUCTION

PROJECT:

HENQIN OCEAN KINGDOM

CLIENT:

Zhuhai Chimelong Investment
 and Development Co., Ltd.
 Chimelong Office G1,
 Fuxiang Bay, Hengqin New
 District
 Zhuhai 519031, People's
 Republic of China

CONSULTANT:

NOTICES:
 THESE PARADE DESIGN DOCUMENTS ARE FOR DESIGN INTENT PURPOSE ONLY AND NOT FOR CONSTRUCTION.

ANY PROJECT ARCHITECTURAL DESIGN, ENGINEERING, CONSTRUCTION, COMMISSIONING, AND COMPLIANCE WITH LOCAL LIFE SAFETY AND BUILDING CODES SHALL BE PROVIDED AND PERFORMED BY LOCALLY LICENSED PROFESSIONALS.

THE DATA IN THIS DOCUMENT INCORPORATE PROPRIETARY RIGHTS OF THE HETEMA GROUP, 67 VALLEY STREET PASADENA, CA 91105. ANY PARTY ACCEPTING THIS DOCUMENT DOES SO IN CONFIDENCE AND AGREES THAT IT SHALL NOT BE DUPLICATED, IN WHOLE OR IN PART, OR BE DISCLOSED TO OTHERS, WITHOUT THE PRIOR WRITTEN CONSENT OF THE HETEMA GROUP, INC. AND ZHUHAI CHIMELONG INVESTMENT AND DEVELOPMENT CO., LTD. CHIMELONG OFFICE G1, FUXIANG BAY, HENQIN NEW DISTRICT ZHUHAI 519031, PEOPLE'S REPUBLIC OF CHINA

**FINAL DESIGN
 PACKAGE UPDATE
 PROGRESS PLOT**

ISSUE DATE	DESCRIPTION
2012/09/10	CONCEPT DESIGN
11-OCT-2012	CONCEPT DEVELOPMENT
-	-
-	-
-	-

DRAWING TITLE:

**CHIMELONG PARADE
 CONCEPT DEVELOPMENT
 FANFARE**

SHEET NO.

D-A1-04

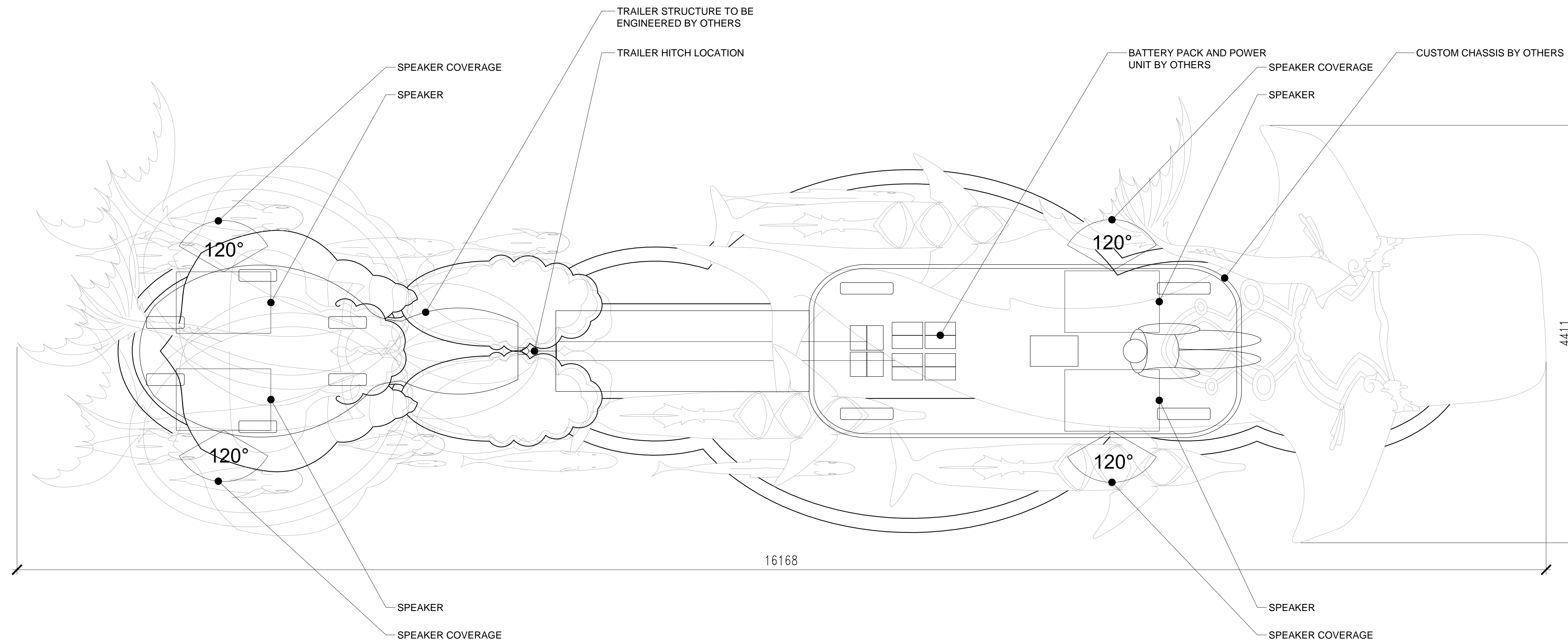
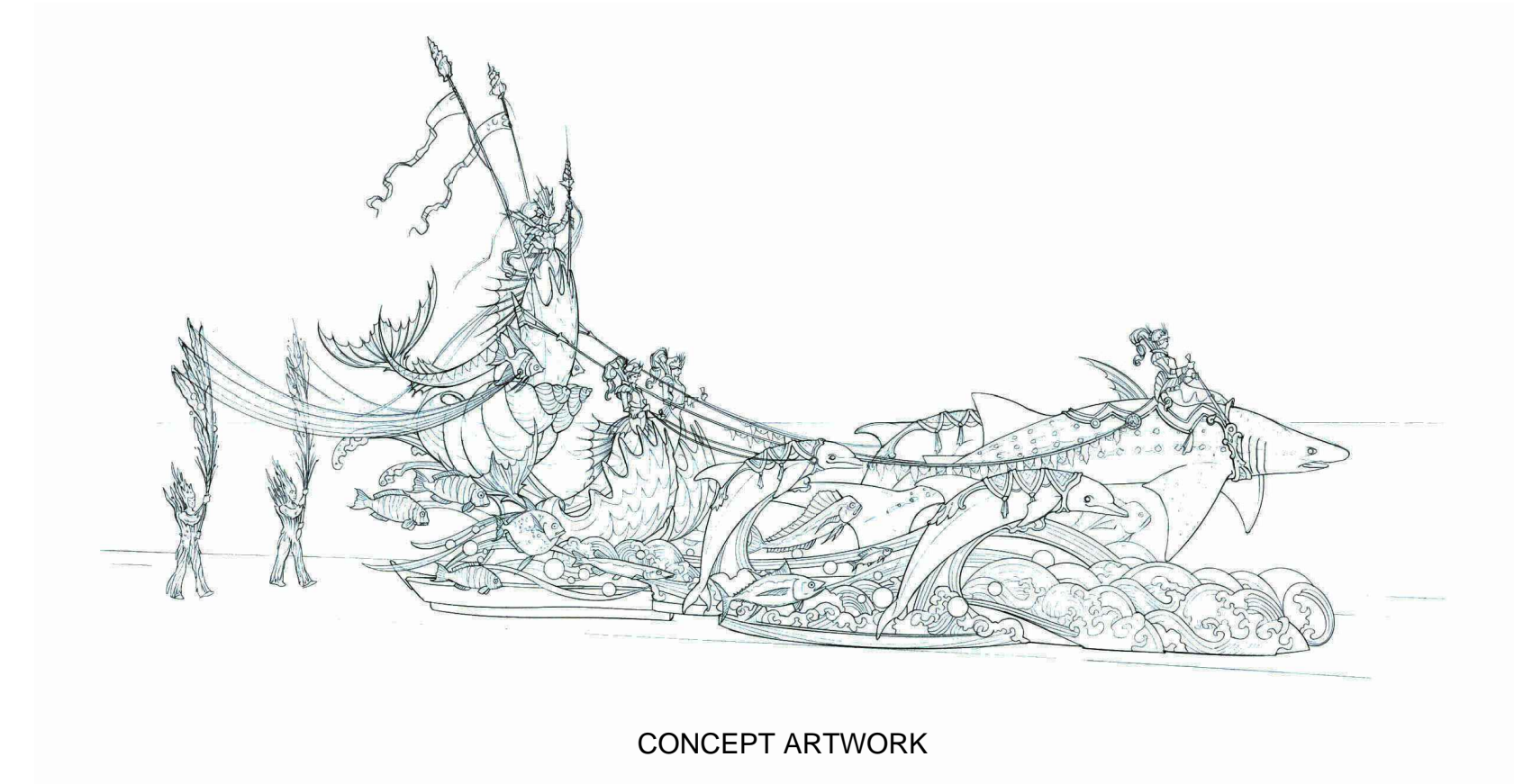

4 CHIMELONG PARADE FANFARE PLAN
 1:25

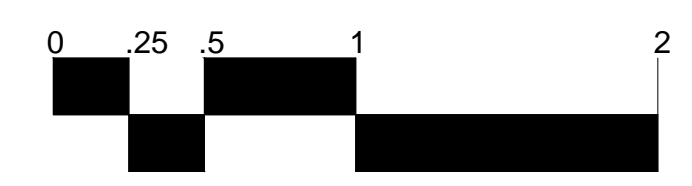

**NOT FOR
CONSTRUCTION**

NUMBER	ANIMATION or EFFECT	DESCRIPTION OF ANIMATION OR EFFECT	QUANTITY
B1-A	ANIMATION	LIONFISH – lunge, body turn, dorsal and pectoral fin unfurling animation – puppet	1
B1-B	ANIMATION	ANEMONE – blossoming/ unfurling animation – puppet	3
B1-C	ANIMATION	ANEMONE – blossoming/ unfurling animation – mechanical	4

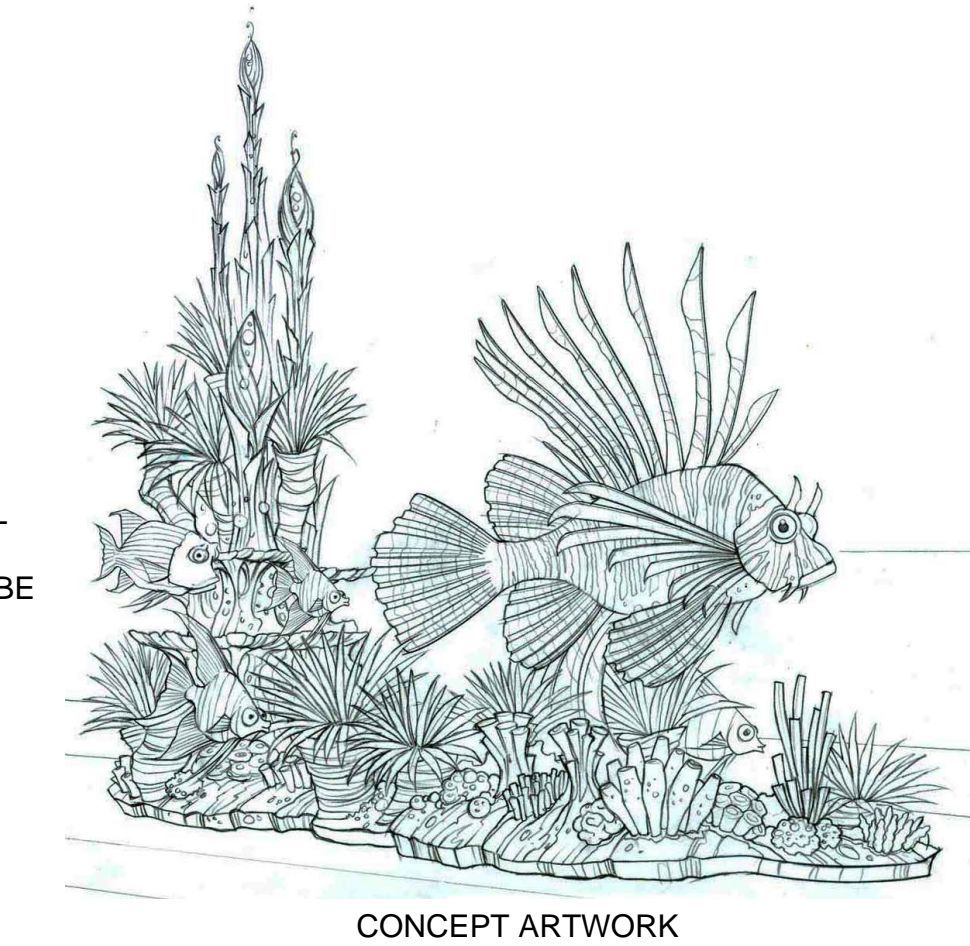
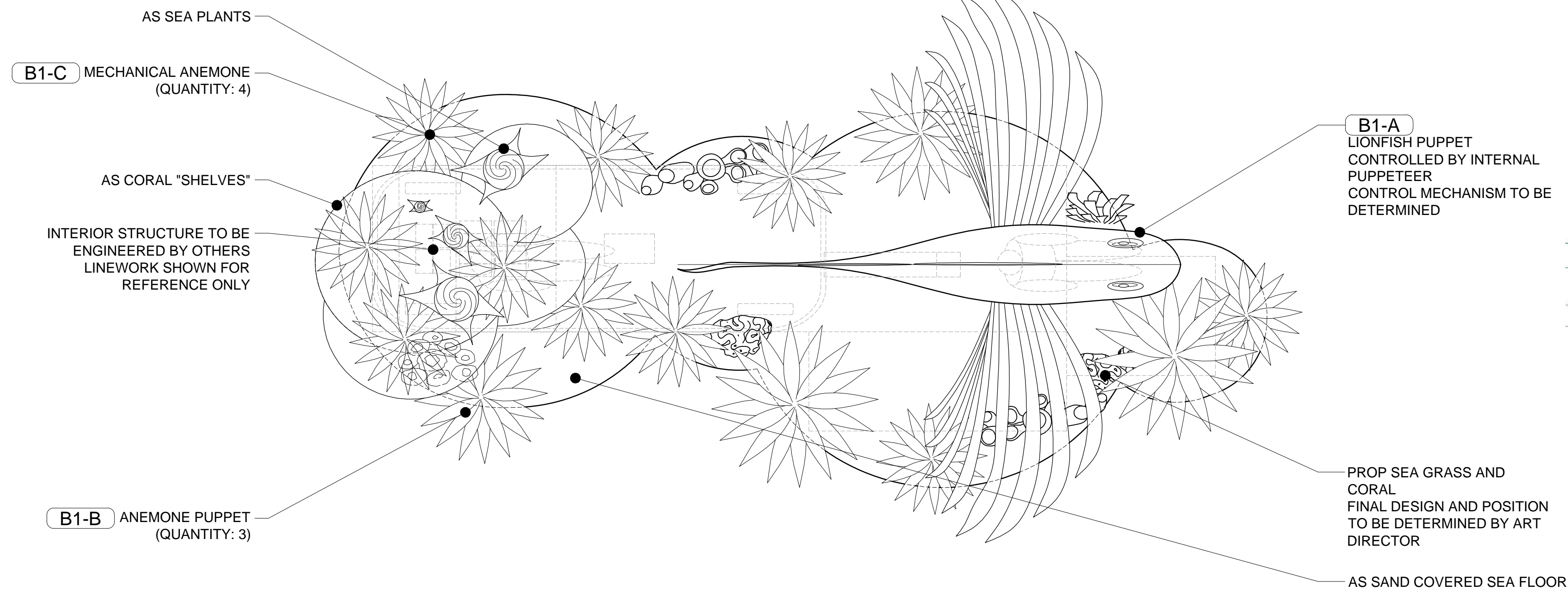

1 CHIMELONG PARADE CORAL REEF: LIONFISH PLAN
1:25



2 CHIMELONG PARADE CORAL REEF: LIONFISH ELEVATION
1:25

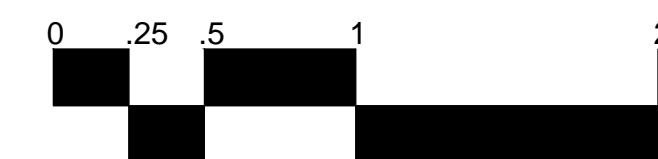

NOT FOR CONSTRUCTION

ISSUE DATE	DESCRIPTION
2012/09/10	CONCEPT DESIGN
11-OCT-2012	CONCEPT DEVELOPMENT
-	-
-	-
-	-

ISSUE DATE	DESCRIPTION
2012/09/10	CONCEPT DESIGN
11-OCT-2012	CONCEPT DEVELOPMENT
-	-
-	-
-	-

DRAWING TITLE:
**CHIMELONG PARADE
 CONCEPT DEVELOPMENT
 CORAL REEF: LIONFISH**

SHEET NO.

D-B1-02

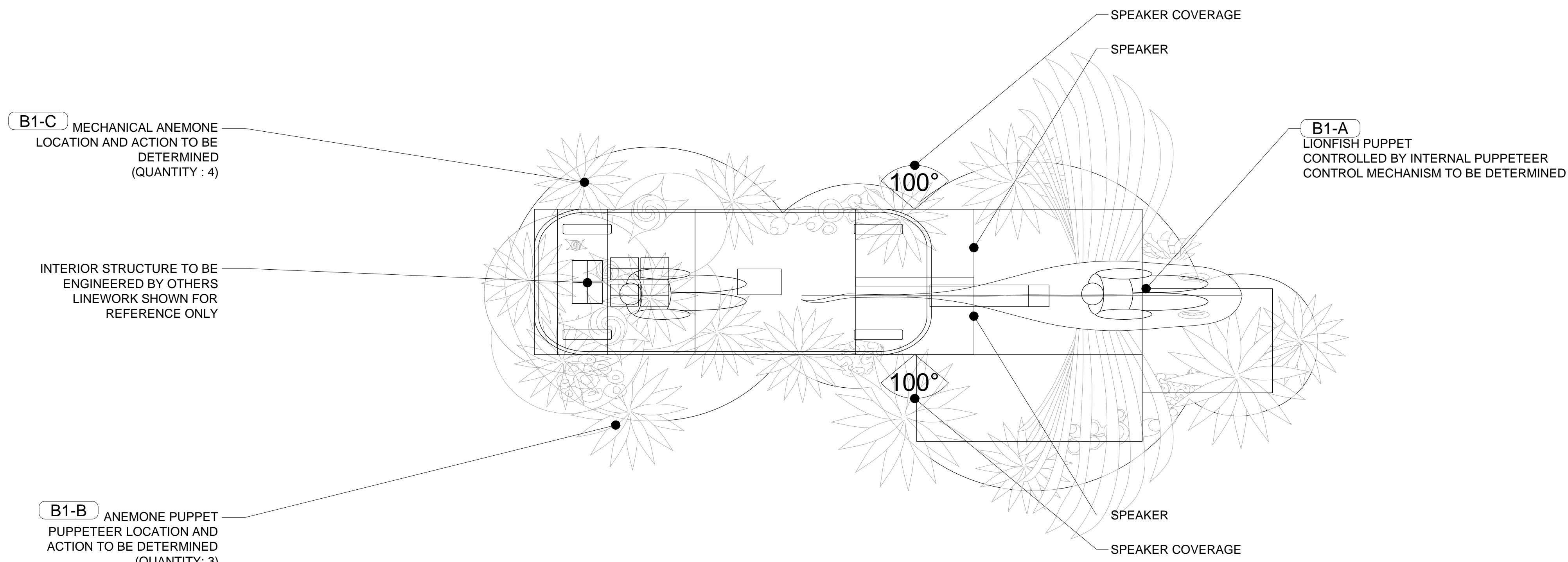
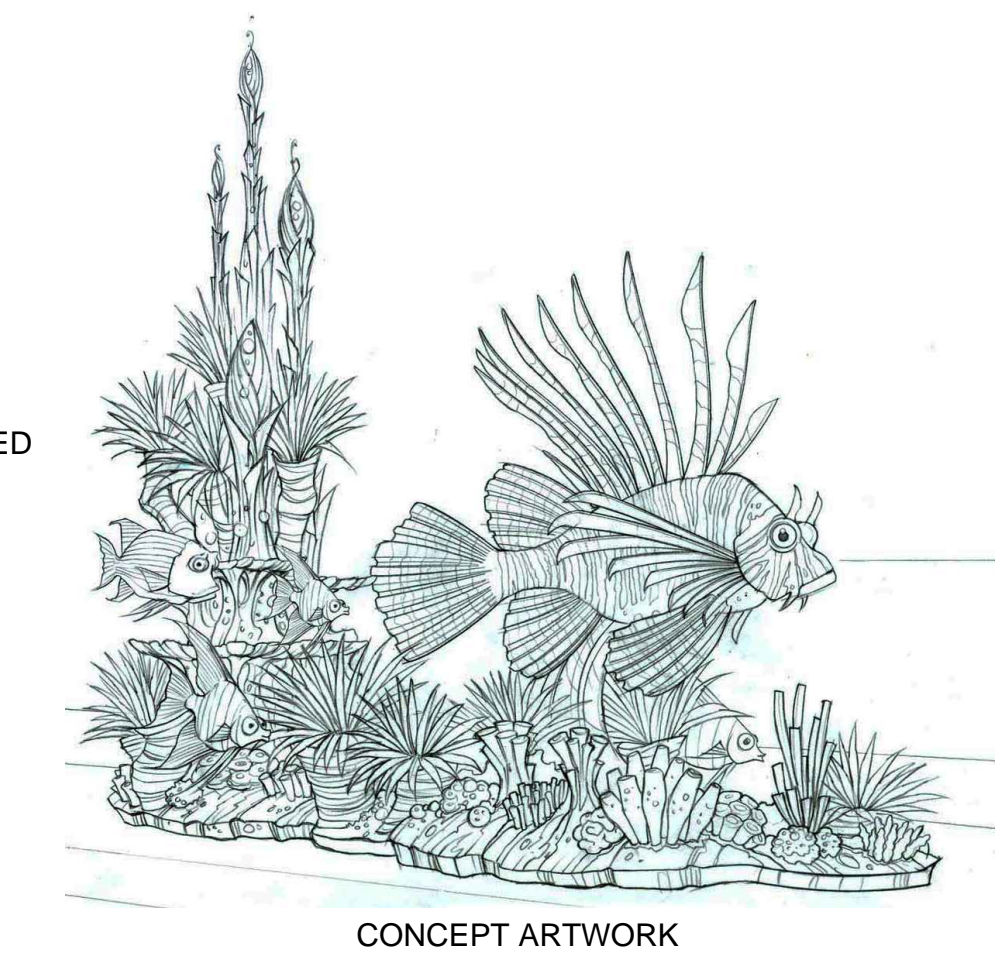

3 CHIMELONG PARADE CORAL REEF: LIONFISH PLAN
 1:25

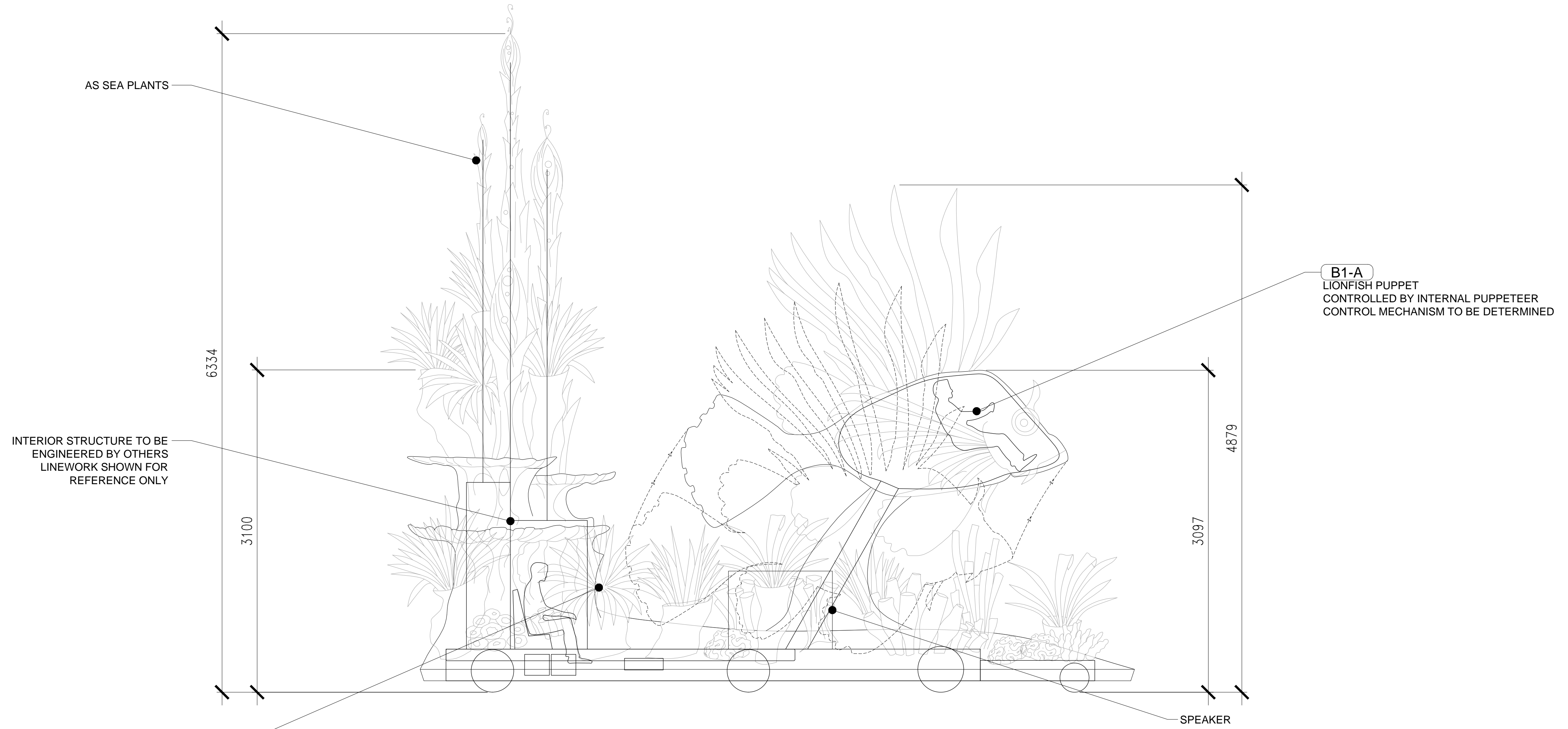

4 CHIMELONG PARADE CORAL REEF: LIONFISH ELEVATION
 1:25



**NOT FOR
 CONSTRUCTION**

NUMBER	ANIMATION or EFFECT	DESCRIPTION OF ANIMATION OR EFFECT	QUANTITY
B2-A	ANIMATION	OCTOPUS – body up/down, body turn, tentacle falling/undulating animation (2 puppet tentacles, 4 mechanical, 2 fixed to scenic) – puppet/mechanical	8
B2-B	ANIMATION	SYNCHRONIZED COLOR-CHANGING SCHOOL OF FISH (24 on each side) – graduated color spheres serving as center of fish bodies rotate on center axis – mechanical	48

PROJECT:

HENQIN OCEAN KINGDOM

CLIENT:

Zhuhai Chimelong Investment and Development Co., Ltd.
 Chimelong Office G1,
 Fuxiang Bay, Hengqin New District
 Zhuhai 519031, People's Republic of China

CONSULTANT:

NOTICES:
 THESE PARADE DESIGN DOCUMENTS ARE FOR DESIGN INTENT PURPOSE ONLY AND NOT FOR CONSTRUCTION.

ANY PROJECT ARCHITECTURAL DESIGN, ENGINEERING, CONSTRUCTION, COMMISSIONING, AND COMPLIANCE WITH LOCAL LIFE SAFETY AND BUILDING CODES SHALL BE PROVIDED AND PERFORMED BY LOCALLY LICENSED PROFESSIONALS.

THE DATA IN THIS DOCUMENT INCORPORATE PROPRIETARY RIGHTS OF THE HETEMA GROUP, 67 VALLEY STREET PASADENA, CA 91105. ANY PARTY ACCEPTING THIS DOCUMENT DOES SO IN CONFIDENCE AND AGREES THAT IT SHALL NOT BE DUPLICATED, IN WHOLE OR IN PART, OR BE DISCLOSED TO OTHERS, WITHOUT THE PRIOR WRITTEN CONSENT OF THE HETEMA GROUP, INC. AND

ZHUHAI CHIMELONG INVESTMENT AND DEVELOPMENT CO., LTD.
 CHIMELONG OFFICE G1,
 FUXIANG BAY, HENQIN NEW DISTRICT
 ZHUHAI 519031, PEOPLE'S REPUBLIC OF CHINA

FINAL DESIGN
 PACKAGE UPDATE
 PROGRESS PLOT

ISSUE DATE	DESCRIPTION
2012/09/10	CONCEPT DESIGN
11-OCT-2012	CONCEPT DEVELOPMENT
-	-
-	-
-	-

DRAWING TITLE:
 CHIMELONG PARADE
 CONCEPT DEVELOPMENT
 CORAL REEF: OCTOPUS

SHEET NO.

D-B2-01

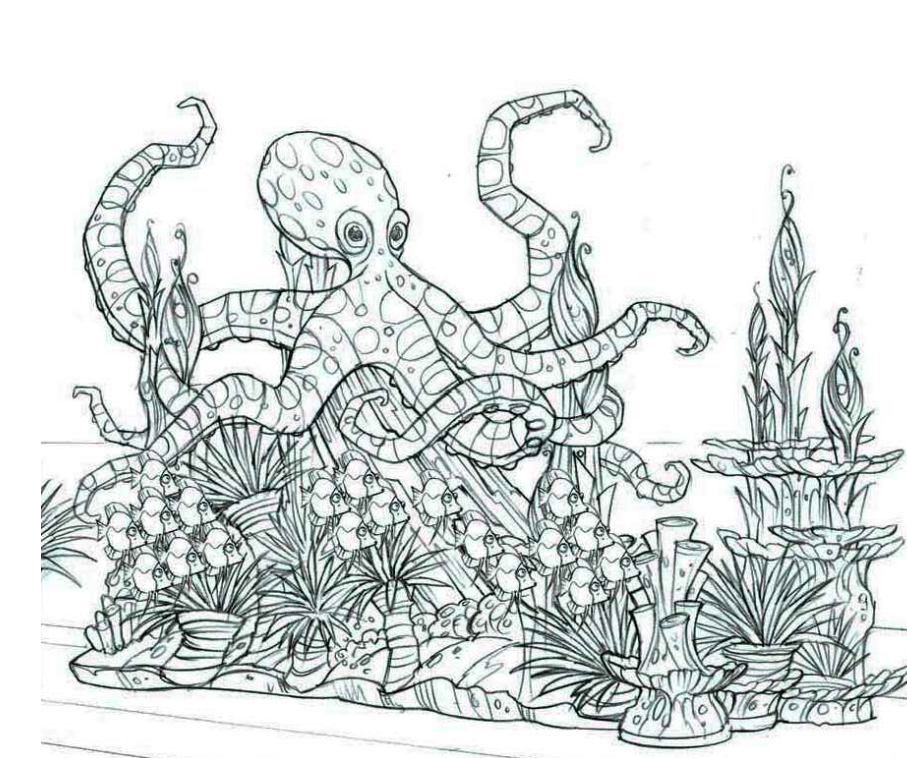

CONCEPT ARTWORK

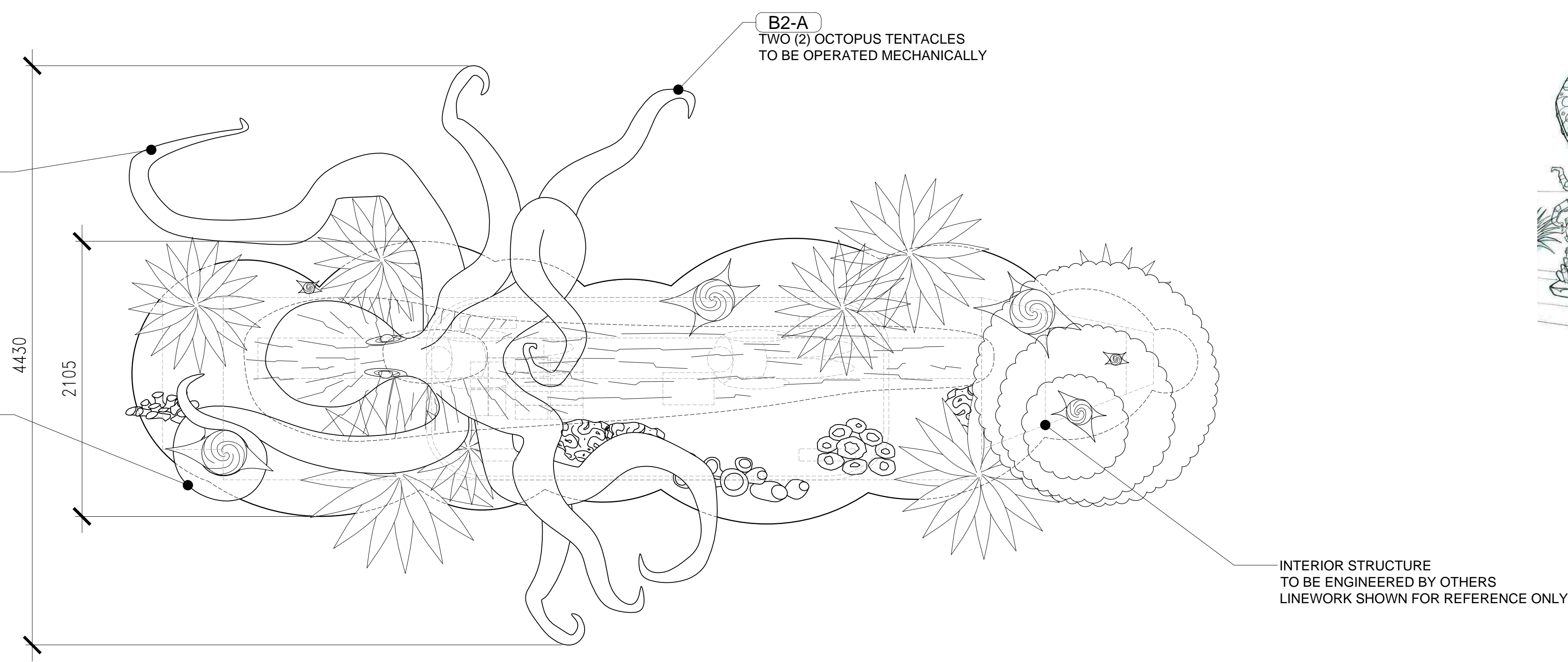

5 CHIMELONG PARADE CORAL REEF: OCTOPUS PLAN
 1:25

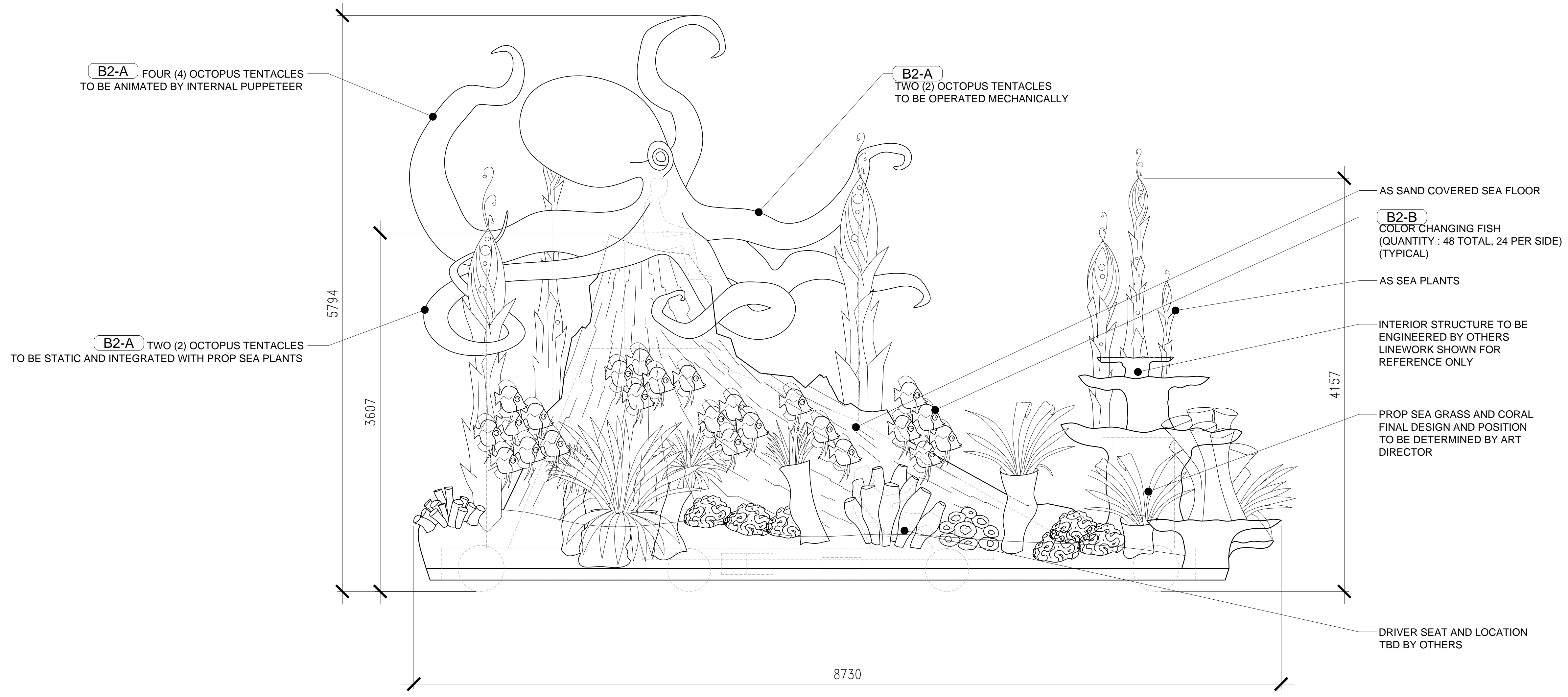

6 CHIMELONG PARADE CORAL REEF: OCTOPUS ELEVATION
 1:25

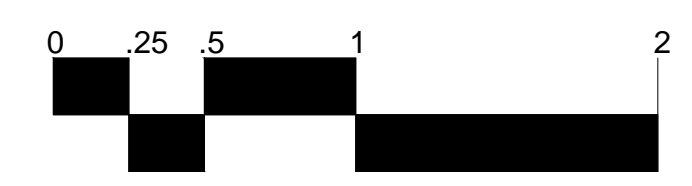

NOT FOR CONSTRUCTION

B1-C

PROJECT:

HENQIN OCEAN KINGDOM

CLIENT:

Zhuhai Chimelong Investment
 and Development Co., Ltd.
 Chimelong Office G1,
 Fuxiang Bay, Hengqin New
 District
 Zhuhai 519031, People's
 Republic of China

CONSULTANT:

NOTICES:
 THESE PARADE DESIGN DOCUMENTS ARE FOR DESIGN INTENT
 PURPOSE ONLY AND NOT FOR CONSTRUCTION.

ANY PROJECT ARCHITECTURAL DESIGN, ENGINEERING,
 CONSTRUCTION, COMMISSIONING, AND COMPLIANCE WITH LOCAL
 LIFE SAFETY AND BUILDING CODES SHALL BE PROVIDED AND
 PERFORMED BY LOCALLY LICENSED PROFESSIONALS.

THE DATA IN THIS DOCUMENT INCORPORATE PROPRIETARY
 RIGHTS OF THE HETEMA GROUP, 67 VALLEY STREET PASADENA,
 CA 91105. ANY PARTY ACCEPTING THIS DOCUMENT DOES SO IN
 CONFIDENCE AND AGREES THAT IT SHALL NOT BE DUPLICATED,
 IN WHOLE OR IN PART, OR BE DISCLOSED TO OTHERS, WITHOUT
 THE PRIOR WRITTEN CONSENT OF THE HETEMA GROUP, INC.

AND
 ZHUHAI CHIMELONG INVESTMENT AND DEVELOPMENT CO., LTD.
 CHIMELONG OFFICE G1,
 FUXIANG BAY, HENQIN NEW DISTRICT
 ZHUHAI 519031, PEOPLE'S REPUBLIC OF CHINA

**FINAL DESIGN
 PACKAGE UPDATE
 PROGRESS PLOT**

ISSUE DATE	DESCRIPTION
2012/09/10	CONCEPT DESIGN
11-OCT-2012	CONCEPT DEVELOPMENT
-	-
-	-
-	-

DRAWING TITLE:
**CHIMELONG PARADE
 CONCEPT DEVELOPMENT
 CORAL REEF: OCTOPUS**

SHEET NO.

D-B2-02

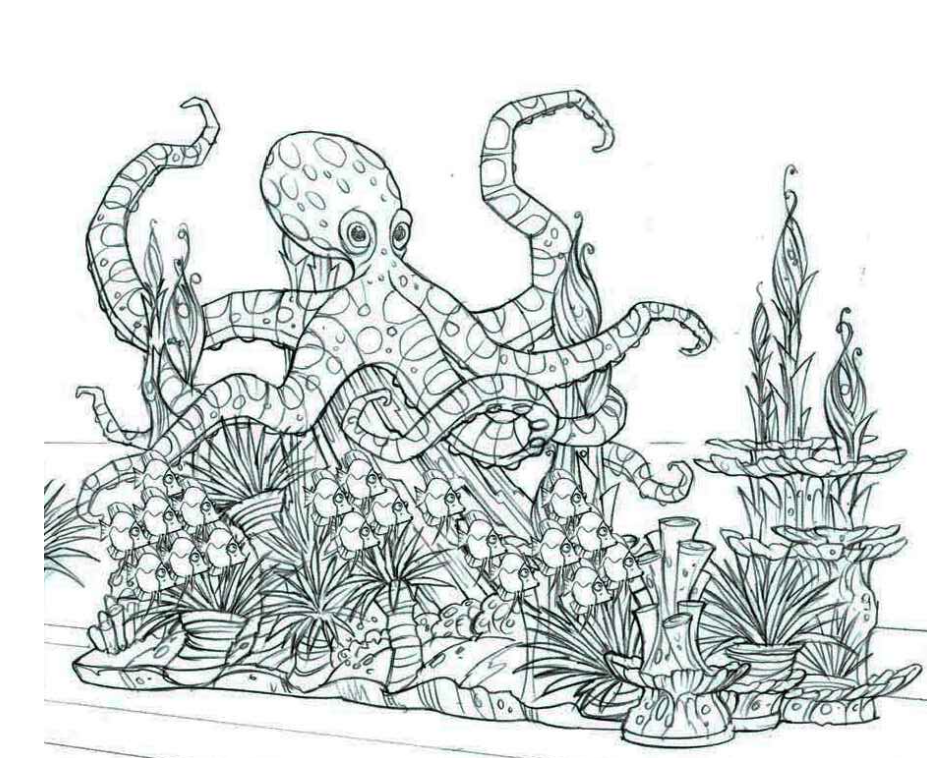

CONCEPT ARTWORK

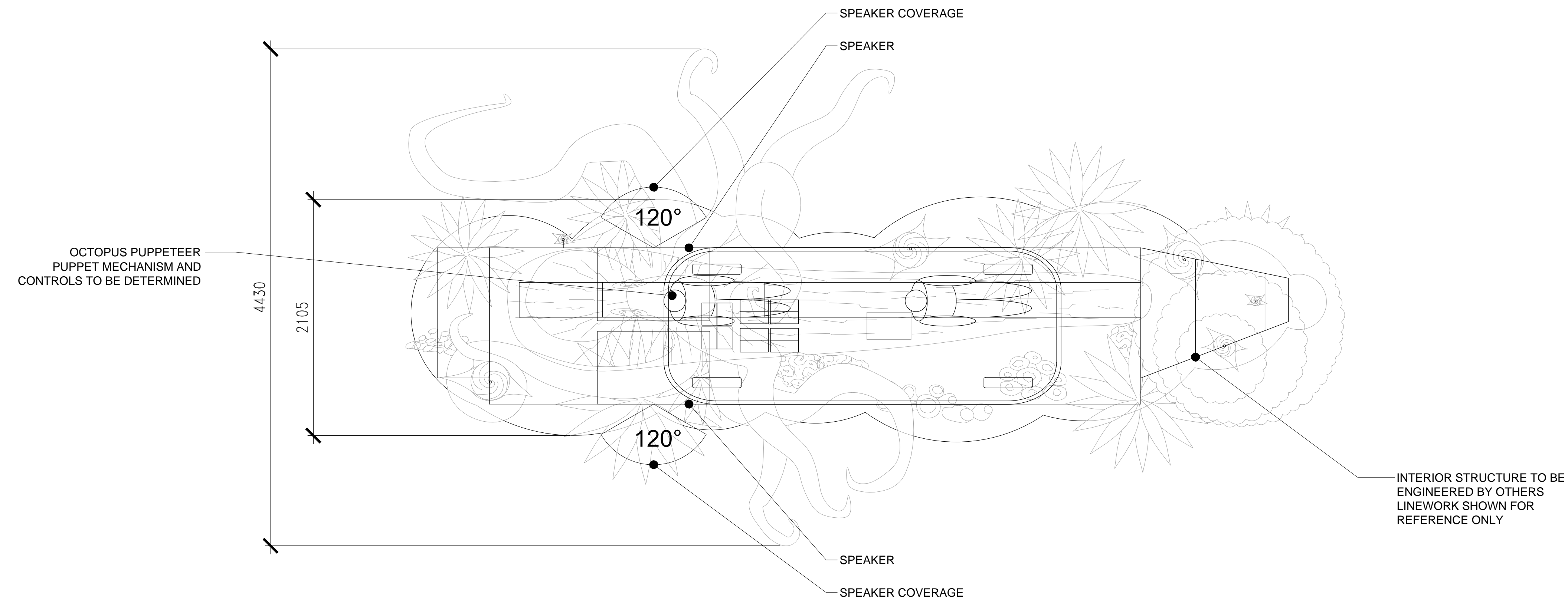

7 CHIMELONG PARADE CORAL REEF: OCTOPUS PLAN
 1:25

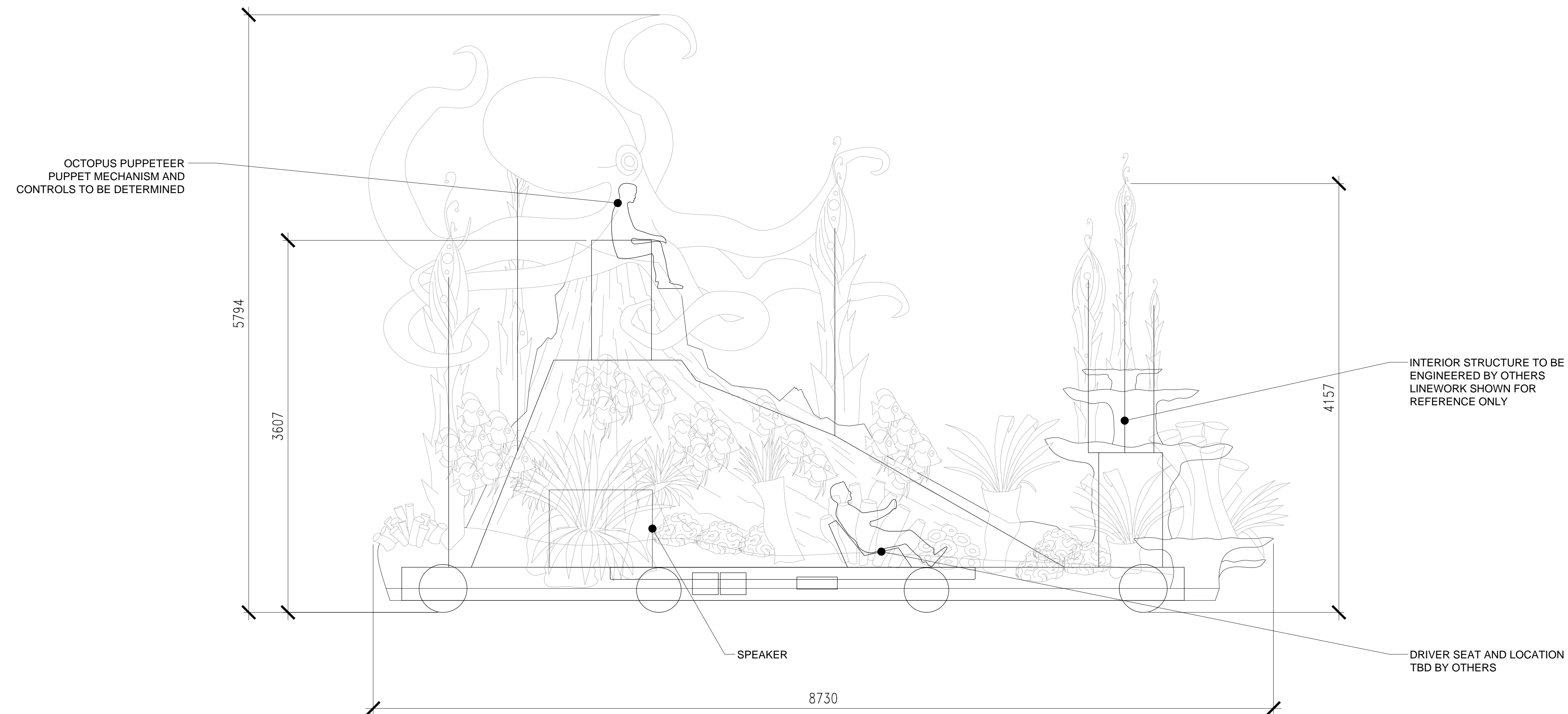

8 CHIMELONG PARADE CORAL REEF: OCTOPUS ELEVATION
 1:25

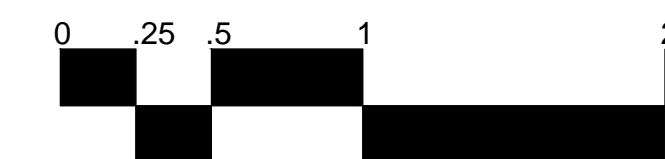

**NOT FOR
CONSTRUCTION**

NUMBER	ANIMATION or EFFECT	DESCRIPTION OF ANIMATION OR EFFECT	QUANTITY
C1-A	ANIMATION	WHIRLING YARDARM WITH FOUR (4) SWINGING SHRIMP – yardarm rotates 360 degrees rapidly – mechanical	1
C1-B	ANIMATION	CANNON POPPER EEL (1 per side) – eel figure pops up and down rapidly inside cannon – mechanical	2
C1-C	ANIMATION	ANCHOR TEETER-TOTTER WITH TWO (2) SEA SNAILS – anchors rocks side to side 20 degrees of motion – mechanical	1
C1-D	ANIMATION	CAPSTAN SHIP'S WHEEL WITH EIGHT (8) PROP FISH ATTACHED – wheel rotates 360 degrees – mechanical	1
C1-E	ANIMATION	PROP FISH (7 total) – leaping animation – mechanical, cam	7

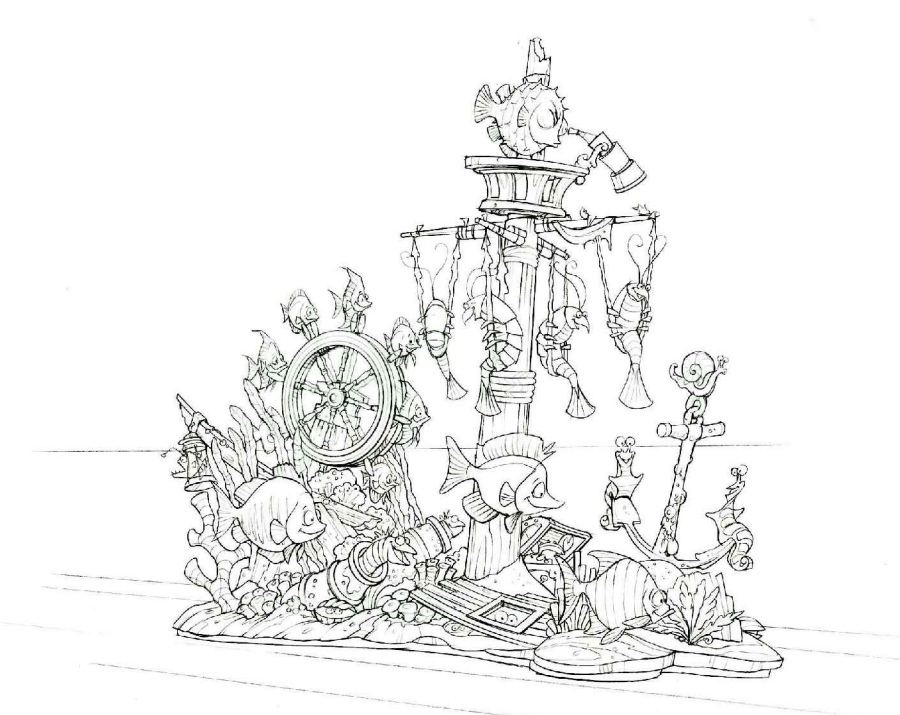

CONCEPT ARTWORK

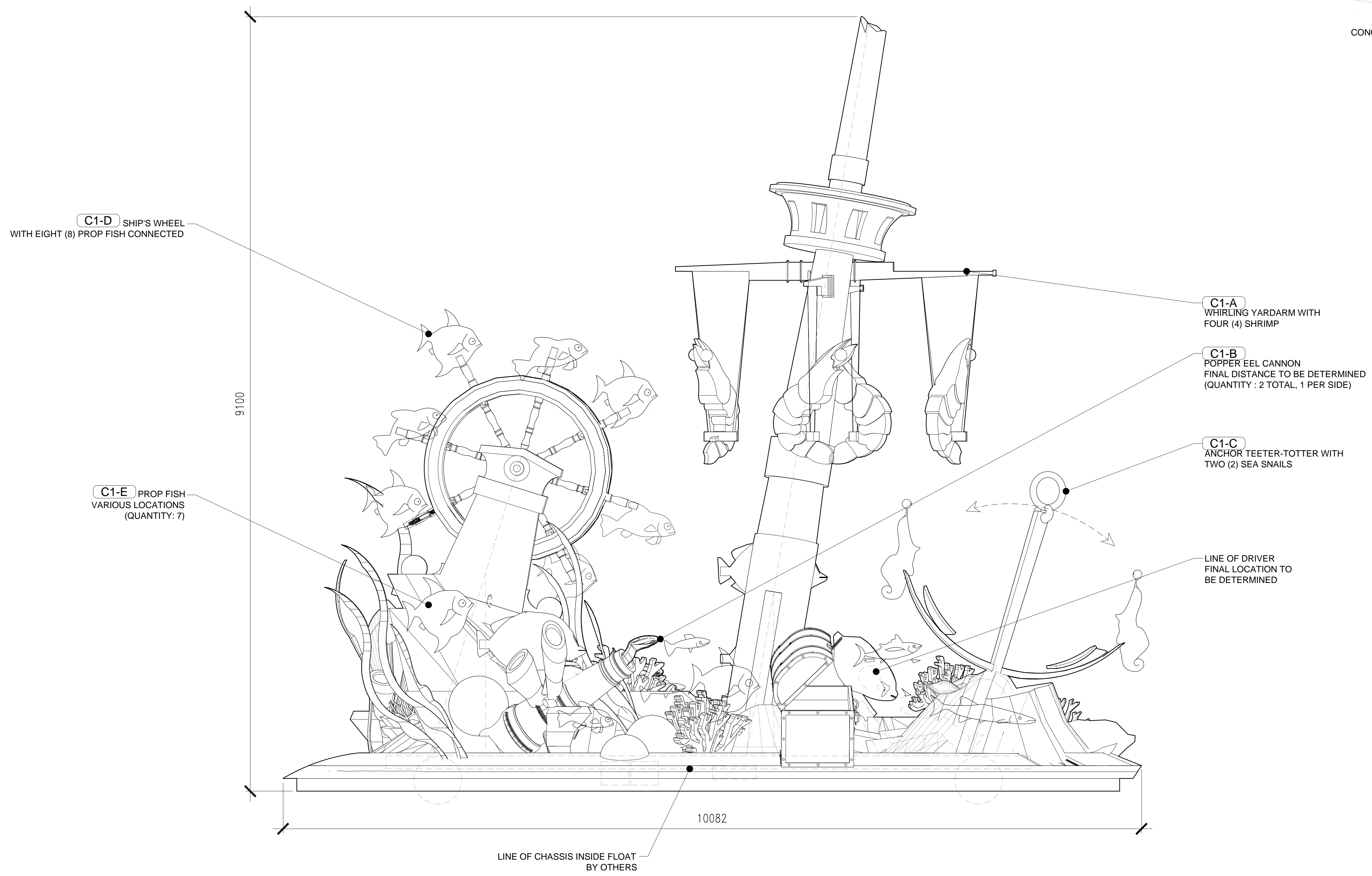

C1-D SHIP'S WHEEL WITH EIGHT (8) PROP FISH CONNECTED

C1-E PROP FISH VARIOUS LOCATIONS (QUANTITY: 7)

C1-A WHIRLING YARDARM WITH FOUR (4) SHRIMP

C1-B POPPER EEL CANNON FINAL DISTANCE TO BE DETERMINED (QUANTITY : 2 TOTAL, 1 PER SIDE)

C1-C ANCHOR TEETER-TOTTER WITH TWO (2) SEA SNAILS

LINE OF DRIVER FINAL LOCATION TO BE DETERMINED

LINE OF CHASSIS INSIDE FLOAT BY OTHERS

1 CHIMELONG PARADE SHIPWRECK PLAYGROUND ELEVATION
1:25

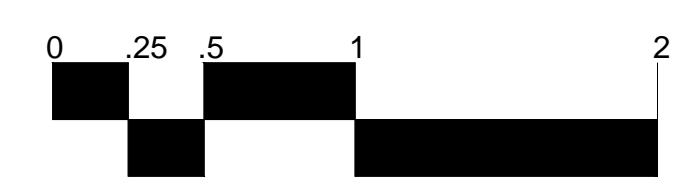

NOT FOR CONSTRUCTION

ISSUE DATE	DESCRIPTION
2012/09/10	CONCEPT DESIGN
11-OCT-2012	CONCEPT DEVELOPMENT
-	-
-	-
-	-

PROJECT:

HENQIN OCEAN KINGDOM

CLIENT:

Zhuhai Chimelong Investment and Development Co., Ltd.
 Chimelong Office G1,
 Fuxiang Bay, Hengqin New District
 Zhuhai 519031, People's Republic of China

CONSULTANT:

NOTICES:
 THESE PARADE DESIGN DOCUMENTS ARE FOR DESIGN INTENT PURPOSE ONLY AND NOT FOR CONSTRUCTION.

ANY PROJECT ARCHITECTURAL DESIGN, ENGINEERING, CONSTRUCTION, COMMISSIONING, AND COMPLIANCE WITH LOCAL LIFE SAFETY AND BUILDING CODES SHALL BE PROVIDED AND PERFORMED BY LOCALLY LICENSED PROFESSIONALS.

THE DATA IN THIS DOCUMENT INCORPORATE PROPRIETARY RIGHTS OF THE HETEMA GROUP, 67 VALLEY STREET PASADENA, CA 91105. ANY PARTY ACCEPTING THIS DOCUMENT DOES SO IN CONFIDENCE AND AGREES THAT IT SHALL NOT BE DUPLICATED, IN WHOLE OR IN PART, OR BE DISCLOSED TO OTHERS, WITHOUT THE PRIOR WRITTEN CONSENT OF THE HETEMA GROUP, INC.

AND
 ZHUHAI CHIMELONG INVESTMENT AND DEVELOPMENT CO., LTD.
 CHIMELONG OFFICE G1,
 FUXIANG BAY, HENQIN NEW DISTRICT
 ZHUHAI 519031, PEOPLE'S REPUBLIC OF CHINA

FINAL DESIGN
 PACKAGE UPDATE
 PROGRESS PLOT

ISSUE DATE	DESCRIPTION
2012/09/10	CONCEPT DESIGN
11-OCT-2012	CONCEPT DEVELOPMENT
-	-
-	-
-	-

DRAWING TITLE:
 CHIMELONG PARADE
 CONCEPT DEVELOPMENT
 SHIPWRECK PLAYGROUND

SHEET NO.

D-C1-02



CONCEPT ARTWORK

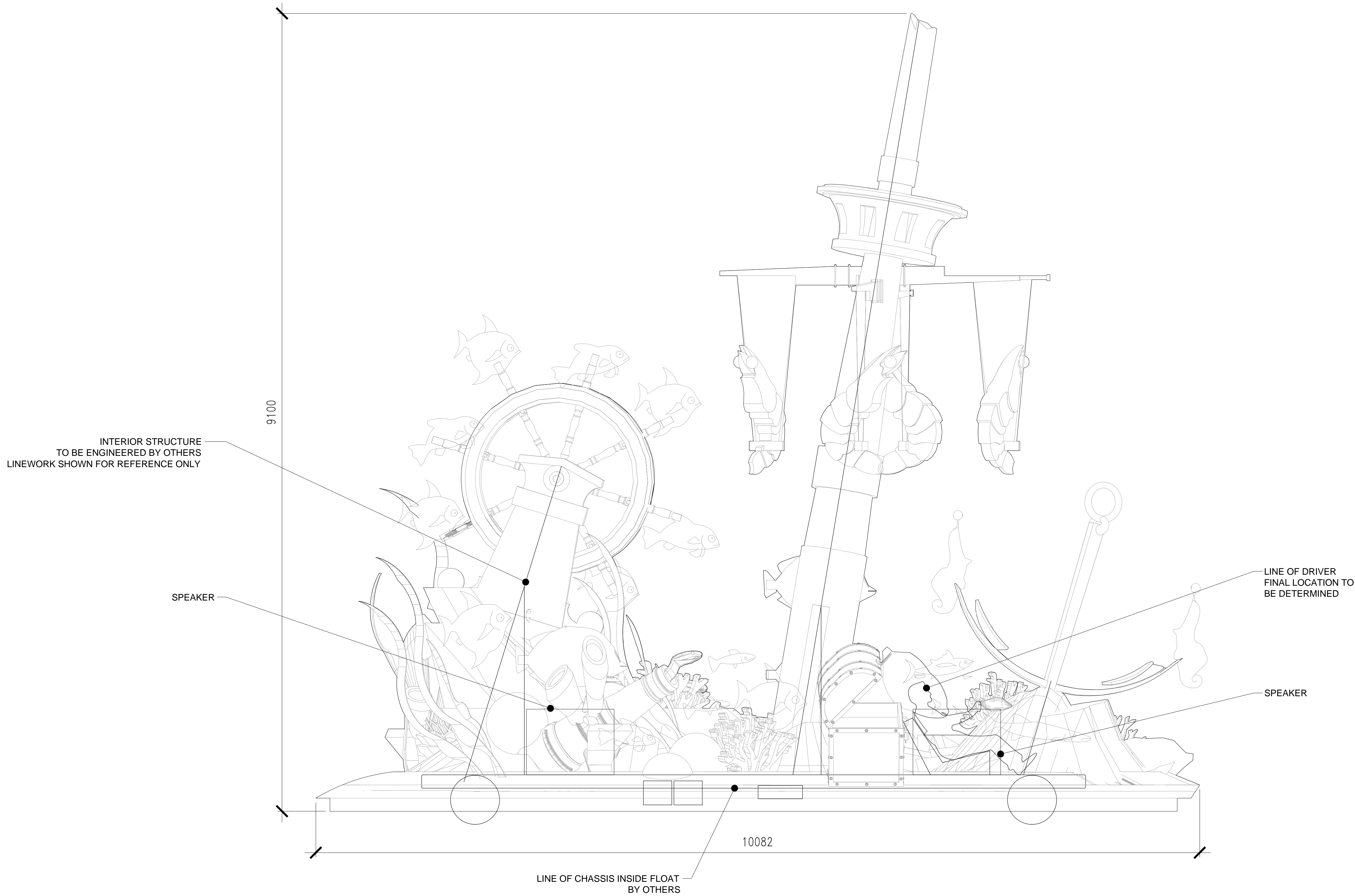

2 CHIMELONG PARADE SHIPWRECK PLAYGROUND ELEVATION
 1:25

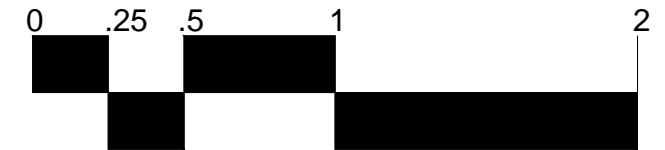

NOT FOR
 CONSTRUCTION

PROJECT:

HENQIN OCEAN KINGDOM

CLIENT:

Zhuhai Chimelong Investment
 and Development Co., Ltd.
 Chimelong Office G1,
 Fuxiang Bay, Hengqin New
 District
 Zhuhai 519031, People's
 Republic of China

CONSULTANT:

NOTICES:
 THESE PARADE DESIGN DOCUMENTS ARE FOR DESIGN INTENT
 PURPOSE ONLY AND NOT FOR CONSTRUCTION.

ANY PROJECT ARCHITECTURAL DESIGN, ENGINEERING,
 CONSTRUCTION, COMMISSIONING, AND COMPLIANCE WITH LOCAL
 LIFE SAFETY AND BUILDING CODES SHALL BE PROVIDED AND
 PERFORMED BY LOCALLY LICENSED PROFESSIONALS.

THE DATA IN THIS DOCUMENT INCORPORATE PROPRIETARY
 RIGHTS OF THE HETEMA GROUP, 67 VALLEY STREET PASADENA,
 CA 91105. ANY PARTY ACCEPTING THIS DOCUMENT DOES SO IN
 CONFIDENCE AND AGREES THAT IT SHALL NOT BE DUPLICATED,
 IN WHOLE OR IN PART, OR BE DISCLOSED TO OTHERS, WITHOUT
 THE PRIOR WRITTEN CONSENT OF THE HETEMA GROUP, INC.
 AND
 ZHUHAI CHIMELONG INVESTMENT AND DEVELOPMENT CO., LTD.
 CHIMELONG OFFICE G1,
 FUXIANG BAY, HENQIN NEW DISTRICT
 ZHUHAI 519031, PEOPLE'S REPUBLIC OF CHINA

**FINAL DESIGN
 PACKAGE UPDATE
 PROGRESS PLOT**

ISSUE DATE	DESCRIPTION
2012/09/10	CONCEPT DESIGN
11-OCT-2012	CONCEPT DEVELOPMENT
-	-
-	-
-	-

DRAWING TITLE:

**CHIMELONG PARADE
 CONCEPT DEVELOPMENT
 SHIPWRECK PLAYGROUND**

SHEET NO.

D-C1-03



CONCEPT ARTWORK

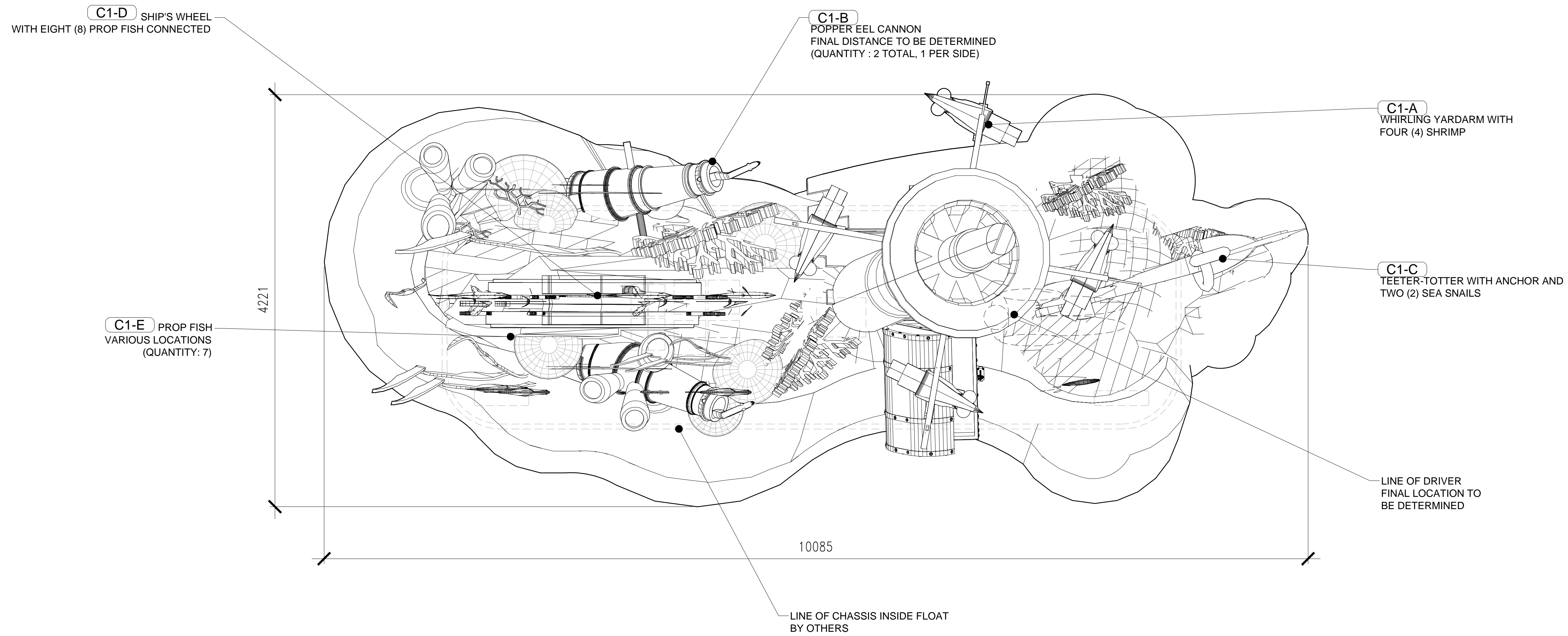

3 CHIMELONG PARADE SHIPWRECK PLAYGROUND PLAN
 1:25

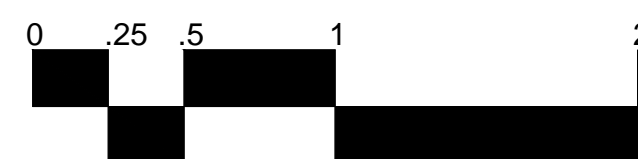

**NOT FOR
 CONSTRUCTION**

PROJECT:

HENQIN OCEAN KINGDOM

CLIENT:

Zhuhai Chimelong Investment
 and Development Co., Ltd.
 Chimelong Office G1,
 Fuxiang Bay, Hengqin New
 District
 Zhuhai 519031, People's
 Republic of China

CONSULTANT:

NOTICES:

THESE PARADE DESIGN DOCUMENTS ARE FOR DESIGN INTENT PURPOSE ONLY AND NOT FOR CONSTRUCTION.

ANY PROJECT ARCHITECTURAL DESIGN, ENGINEERING, CONSTRUCTION, COMMISSIONING, AND COMPLIANCE WITH LOCAL LIFE SAFETY AND BUILDING CODES SHALL BE PROVIDED AND PERFORMED BY LOCALLY LICENSED PROFESSIONALS.

THE DATA IN THIS DOCUMENT INCORPORATE PROPRIETARY RIGHTS OF THE HETEMA GROUP, 67 VALLEY STREET PASADENA, CA 91105. ANY PARTY ACCEPTING THIS DOCUMENT DOES SO IN CONFIDENCE AND AGREES THAT IT SHALL NOT BE DUPLICATED, IN WHOLE OR IN PART, OR BE DISCLOSED TO OTHERS, WITHOUT THE PRIOR WRITTEN CONSENT OF THE HETEMA GROUP, INC.

AND
 ZHUHAI CHIMELONG INVESTMENT AND DEVELOPMENT CO., LTD.
 CHIMELONG OFFICE G1,
 FUXIANG BAY, HENQIN NEW DISTRICT
 ZHUHAI 519031, PEOPLE'S REPUBLIC OF CHINA

**FINAL DESIGN
 PACKAGE UPDATE
 PROGRESS PLOT**

ISSUE DATE	DESCRIPTION
2012/09/10	CONCEPT DESIGN
11-OCT-2012	CONCEPT DEVELOPMENT
-	-
-	-
-	-

DRAWING TITLE:
**CHIMELONG PARADE
 CONCEPT DEVELOPMENT
 SHIPWRECK PLAYGROUND**

SHEET NO.
D-C1-04

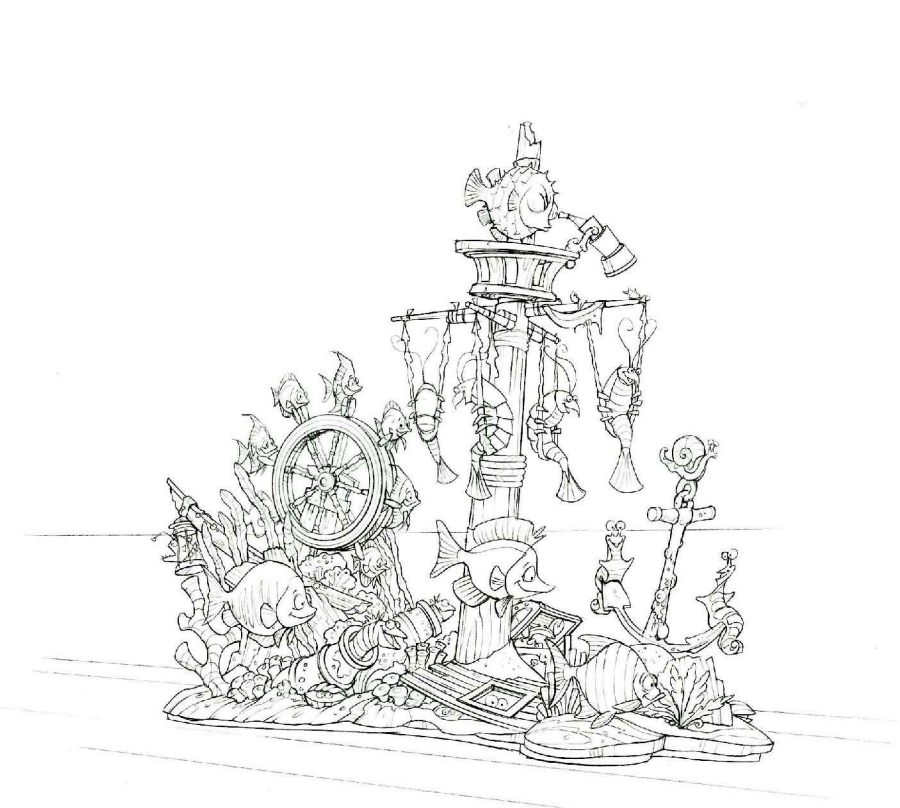

CONCEPT ARTWORK

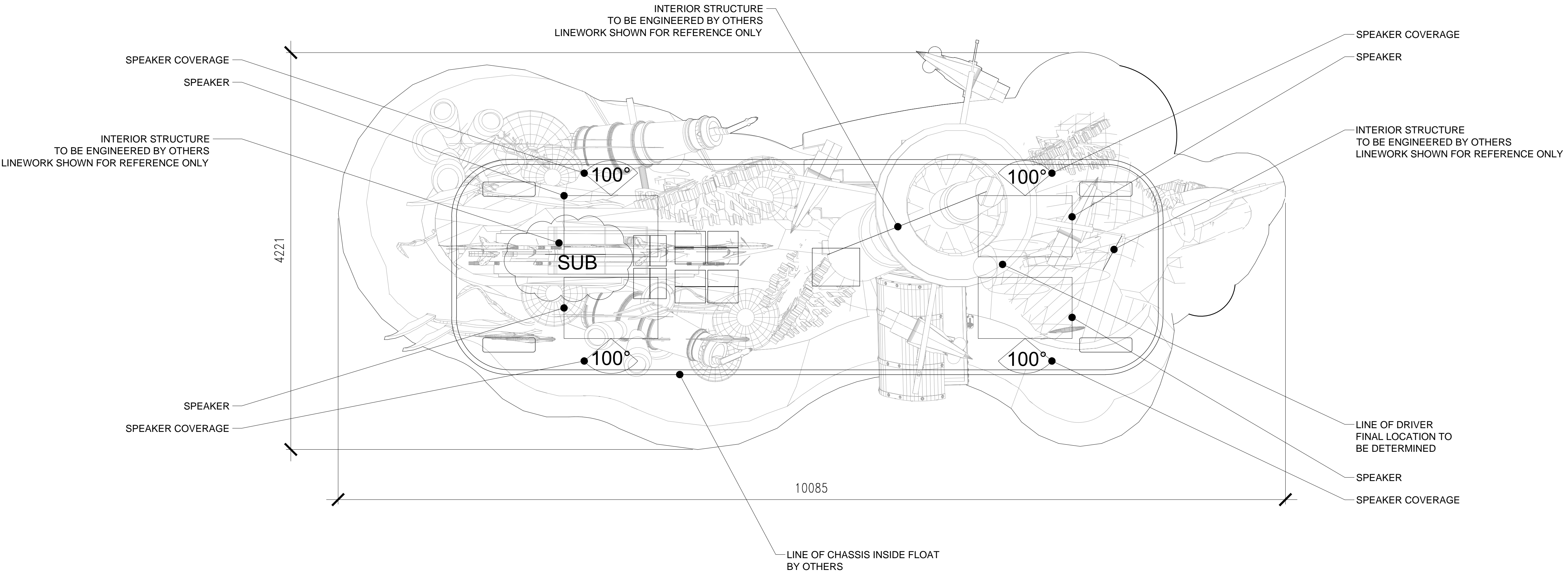

4 CHIMELONG PARADE SHIPWRECK PLAYGROUND PLAN
 1:25

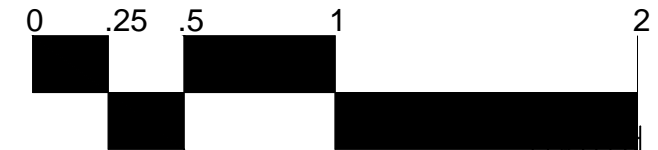

**NOT FOR
 CONSTRUCTION**

NUMBER	ANIMATION or EFFECT	DESCRIPTION OF ANIMATION OR EFFECT	QUANTITY
C2-A	ANIMATION	ARM AND NET - Diver's left arm rotates rapidly, approx. 90 degrees at shoulder - mechanical	1
C2-B	ANIMATION	TINY FISH - fish bobs on the end of wire/ carbon fiber rod attached to net - reactive animation	1
C2-C	EFFECT	VIDEO SCREEN FACE - Diver's face is animated media playing on video screen masked into helmet	1
C2-D	EFFECT	BUBBLES - bubbles trail from helmet	1



CONCEPT ARTWORK

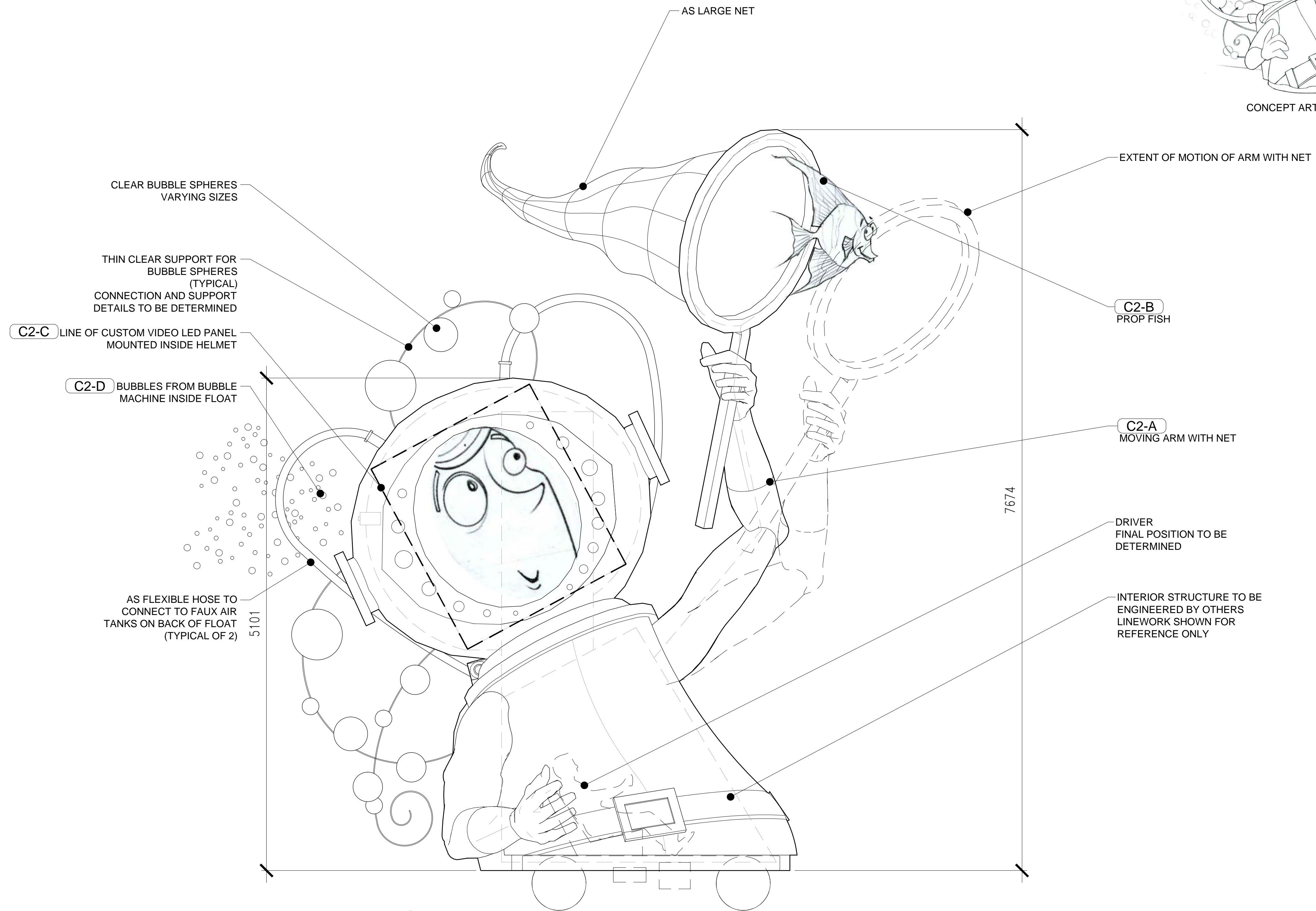

1 CHIMELONG PARADE DIVER ELEVATION
1:25

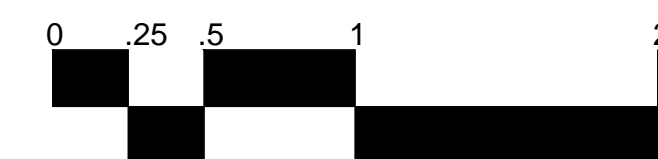

NOT FOR CONSTRUCTION

PROJECT:

HENQIN OCEAN KINGDOM

CLIENT:

Zhuhai Chimelong Investment and Development Co., Ltd.
Chimelong Office G1,
Fuxiang Bay, Hengqin New District
Zhuhai 519031, People's Republic of China

CONSULTANT:

NOTICES:
THESE PARADE DESIGN DOCUMENTS ARE FOR DESIGN INTENT PURPOSE ONLY AND NOT FOR CONSTRUCTION.

ANY PROJECT ARCHITECTURAL DESIGN, ENGINEERING, CONSTRUCTION, COMMISSIONING, AND COMPLIANCE WITH LOCAL LIFE SAFETY AND BUILDING CODES SHALL BE PROVIDED AND PERFORMED BY LOCALLY LICENSED PROFESSIONALS.

THE DATA IN THIS DOCUMENT INCORPORATE PROPRIETARY RIGHTS OF THE HETEMA GROUP, 67 VALLEY STREET PASADENA, CA 91105. ANY PARTY ACCEPTING THIS DOCUMENT DOES SO IN CONFIDENCE AND AGREES THAT IT SHALL NOT BE DUPLICATED, IN WHOLE OR IN PART, OR BE DISCLOSED TO OTHERS, WITHOUT THE PRIOR WRITTEN CONSENT OF THE HETEMA GROUP, INC. AND ZHUHAI CHIMELONG INVESTMENT AND DEVELOPMENT CO., LTD. CHIMELONG OFFICE G1, FUXIANG BAY, HENQIN NEW DISTRICT ZHUHAI 519031, PEOPLE'S REPUBLIC OF CHINA

FINAL DESIGN PACKAGE UPDATE PROGRESS PLOT

ISSUE DATE	DESCRIPTION
2012/09/10	CONCEPT DESIGN
11-OCT-2012	CONCEPT DEVELOPMENT

DRAWING TITLE:

CHIMELONG PARADE CONCEPT DEVELOPMENT DIVER

SHEET NO.

D-C2-01

PROJECT:

HENQIN OCEAN KINGDOM

CLIENT:

**Zuhai Chimelong Investment
 and Development Co., Ltd.**
 Chimelong Office G1,
 Fuxiang Bay, Hengqin New
 District
 Zhuhai 519031, People's
 Republic of China

CONSULTANT:

NOTICES:
 THESE PARADE DESIGN DOCUMENTS ARE FOR DESIGN INTENT
 PURPOSE ONLY AND NOT FOR CONSTRUCTION.

ANY PROJECT ARCHITECTURAL DESIGN, ENGINEERING,
 CONSTRUCTION, COMMISSIONING, AND COMPLIANCE WITH LOCAL
 LIFE SAFETY AND BUILDING CODES SHALL BE PROVIDED AND
 PERFORMED BY LOCALLY LICENSED PROFESSIONALS.

THE DATA IN THIS DOCUMENT INCORPORATE PROPRIETARY
 RIGHTS OF THE HETEMA GROUP, 67 VALLEY STREET PASADENA,
 CA 91105. ANY PARTY ACCEPTING THIS DOCUMENT DOES SO IN
 CONFIDENCE AND AGREES THAT IT SHALL NOT BE DUPLICATED,
 IN WHOLE OR IN PART, OR BE DISCLOSED TO OTHERS, WITHOUT
 THE PRIOR WRITTEN CONSENT OF THE HETEMA GROUP, INC.
 AND
 ZUHAI CHIMELONG INVESTMENT AND DEVELOPMENT CO., LTD.
 CHIMELONG OFFICE G1,
 FUXIANG BAY, HENQIN NEW DISTRICT
 ZHUHAI 519031, PEOPLE'S REPUBLIC OF CHINA

**FINAL DESIGN
 PACKAGE UPDATE
 PROGRESS PLOT**

ISSUE DATE	DESCRIPTION
------------	-------------

2012/09/10	CONCEPT DESIGN
------------	----------------

11-OCT-2012	CONCEPT DEVELOPMENT
-------------	---------------------

-	-
---	---

-	-
---	---

-	-
---	---

DRAWING TITLE:
**CHIMELONG PARADE
 CONCEPT DEVELOPMENT
 DIVER**

SHEET NO.

D-C2-02



CONCEPT ARTWORK

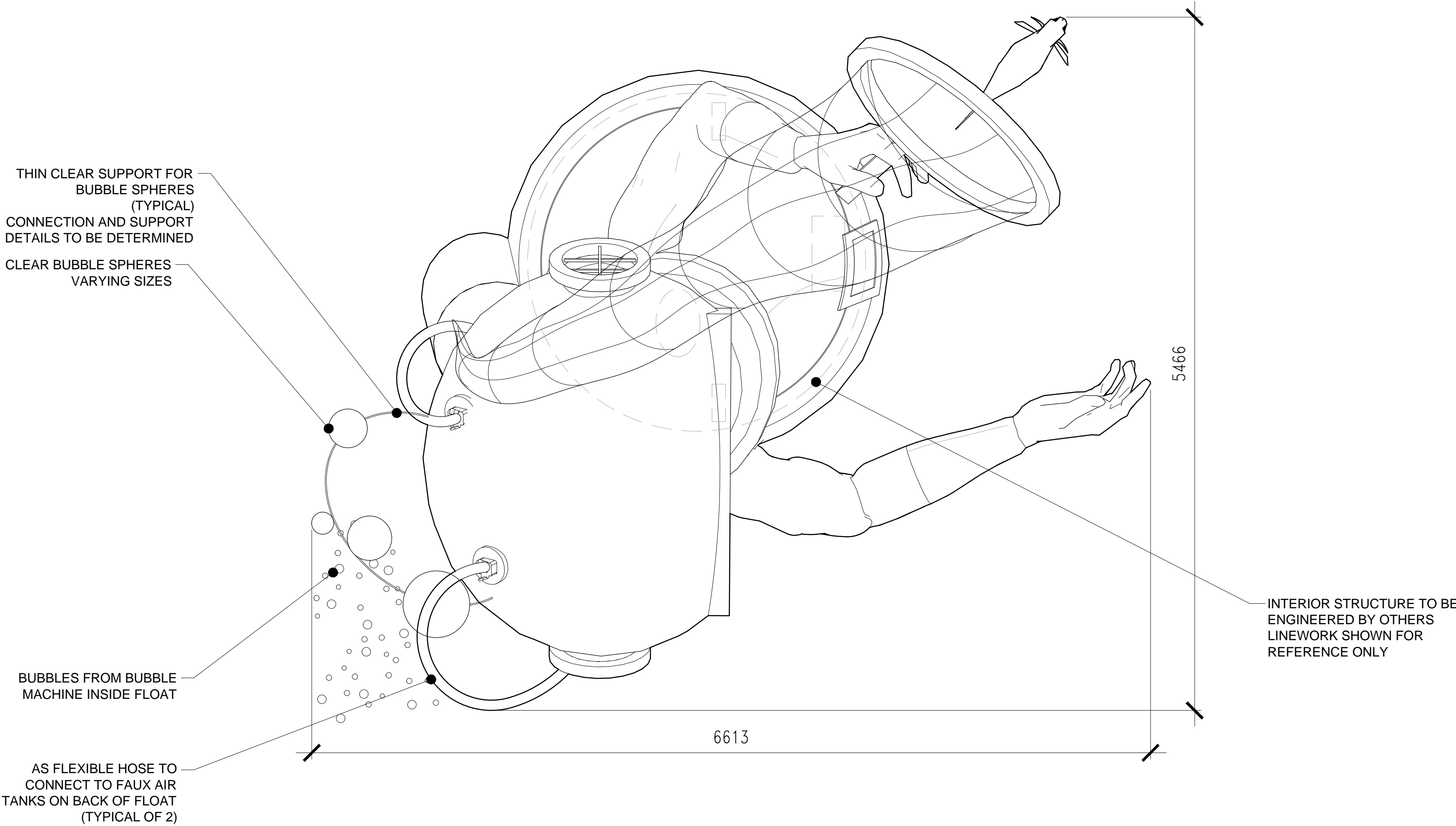

2 CHIMELONG PARADE DIVER PLAN
 1:25

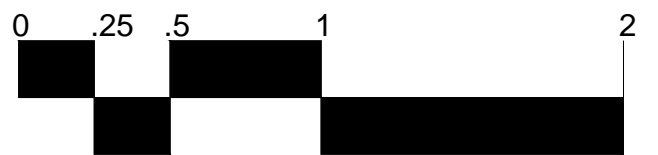

**NOT FOR
 CONSTRUCTION**

PROJECT:

HENQIN OCEAN KINGDOM

CLIENT:

Zhuhai Chimelong Investment
 and Development Co., Ltd.
 Chimelong Office G1,
 Fuxiang Bay, Hengqin New
 District
 Zhuhai 519031, People's
 Republic of China

CONSULTANT:

NOTICES:
 THESE PARADE DESIGN DOCUMENTS ARE FOR DESIGN INTENT
 PURPOSE ONLY AND NOT FOR CONSTRUCTION.

ANY PROJECT ARCHITECTURAL DESIGN, ENGINEERING,
 CONSTRUCTION, COMMISSIONING, AND COMPLIANCE WITH LOCAL
 LIFE SAFETY AND BUILDING CODES SHALL BE PROVIDED AND
 PERFORMED BY LOCALLY LICENSED PROFESSIONALS.

THE DATA IN THIS DOCUMENT INCORPORATE PROPRIETARY
 RIGHTS OF THE HETEMA GROUP, 67 VALLEY STREET PASADENA,
 CA 91105. ANY PARTY ACCEPTING THIS DOCUMENT DOES SO IN
 CONFIDENCE AND AGREES THAT IT SHALL NOT BE DUPLICATED,
 IN WHOLE OR IN PART, OR BE DISCLOSED TO OTHERS, WITHOUT
 THE PRIOR WRITTEN CONSENT OF THE HETEMA GROUP, INC.
 AND
 ZHUHAI CHIMELONG INVESTMENT AND DEVELOPMENT CO., LTD.
 CHIMELONG OFFICE G1,
 FUXIANG BAY, HENQIN NEW DISTRICT
 ZHUHAI 519031, PEOPLE'S REPUBLIC OF CHINA

**FINAL DESIGN
 PACKAGE UPDATE
 PROGRESS PLOT**

ISSUE DATE	DESCRIPTION
2012/09/10	CONCEPT DESIGN
11-OCT-2012	CONCEPT DEVELOPMENT
-	-
-	-
-	-

DRAWING TITLE:

**CHIMELONG PARADE
 CONCEPT DEVELOPMENT
 DIVER**

SHEET NO.

D-C2-03



CONCEPT ARTWORK

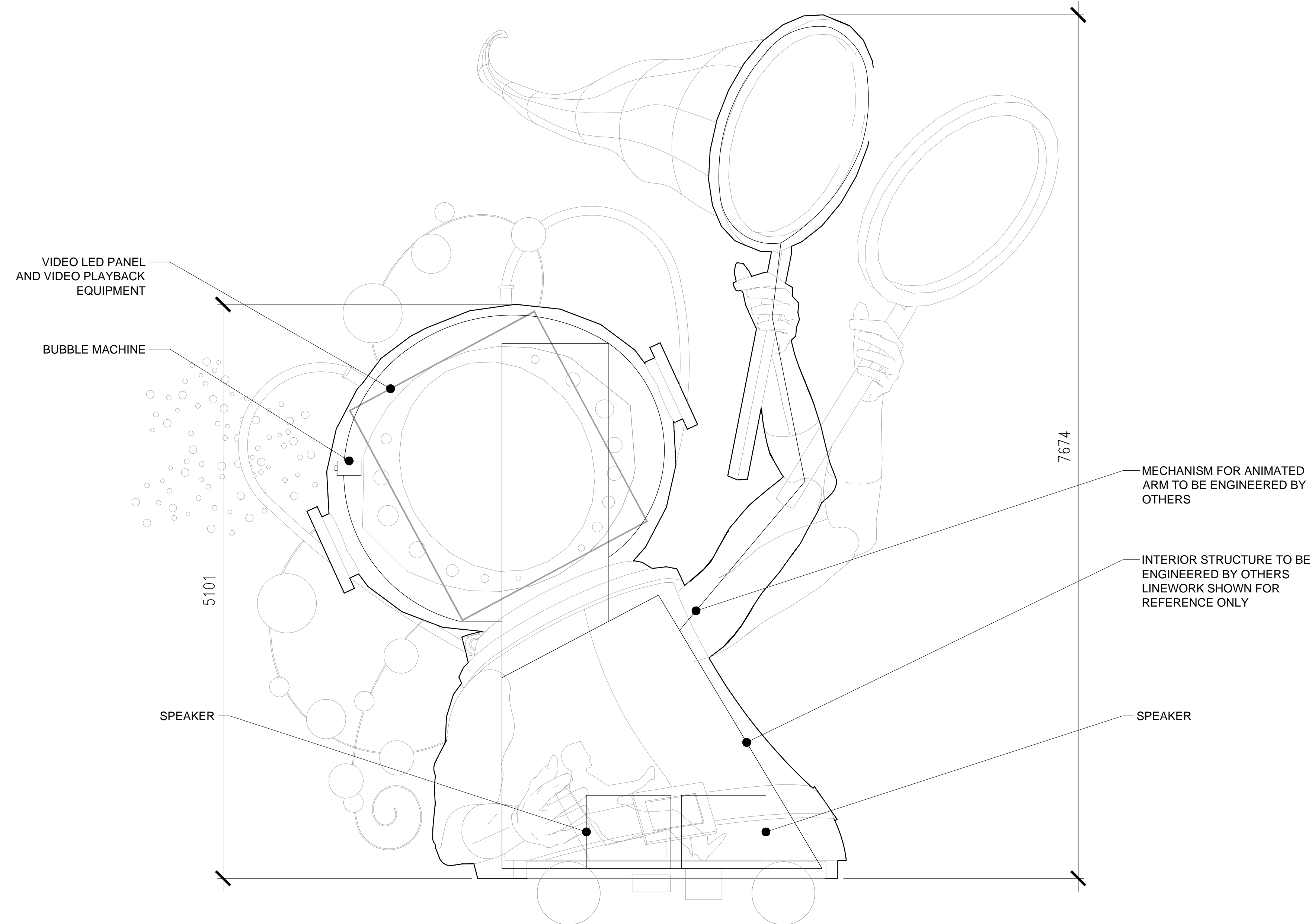

3 CHIMELONG PARADE DIVER ELEVATION
 1:25

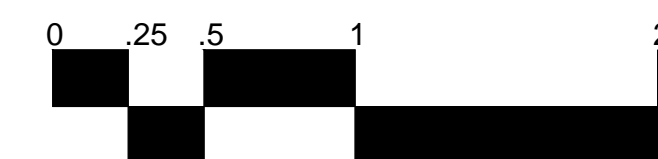

**NOT FOR
 CONSTRUCTION**

PROJECT:

HENQIN OCEAN KINGDOM

CLIENT:

Zhuhai Chimelong Investment
 and Development Co., Ltd.
 Chimelong Office G1,
 Fuxiang Bay, Hengqin New
 District
 Zhuhai 519031, People's
 Republic of China

CONSULTANT:

NOTICES:
 THESE PARADE DESIGN DOCUMENTS ARE FOR DESIGN INTENT
 PURPOSE ONLY AND NOT FOR CONSTRUCTION.

ANY PROJECT ARCHITECTURAL DESIGN, ENGINEERING,
 CONSTRUCTION, COMMISSIONING, AND COMPLIANCE WITH LOCAL
 LIFE SAFETY AND BUILDING CODES SHALL BE PROVIDED AND
 PERFORMED BY LOCALLY LICENSED PROFESSIONALS.

THE DATA IN THIS DOCUMENT INCORPORATE PROPRIETARY
 RIGHTS OF THE HETEMA GROUP, 67 VALLEY STREET PASADENA,
 CA 91105. ANY PARTY ACCEPTING THIS DOCUMENT DOES SO IN
 CONFIDENCE AND AGREES THAT IT SHALL NOT BE DUPLICATED,
 IN WHOLE OR IN PART, OR BE DISCLOSED TO OTHERS, WITHOUT
 THE PRIOR WRITTEN CONSENT OF THE HETEMA GROUP, INC.
 AND
 ZHUHAI CHIMELONG INVESTMENT AND DEVELOPMENT CO., LTD.
 CHIMELONG OFFICE G1,
 FUXIANG BAY, HENQIN NEW DISTRICT
 ZHUHAI 519031, PEOPLE'S REPUBLIC OF CHINA

**FINAL DESIGN
 PACKAGE UPDATE
 PROGRESS PLOT**

ISSUE DATE	DESCRIPTION
------------	-------------

2012/09/10	CONCEPT DESIGN
------------	----------------

11-OCT-2012	CONCEPT DEVELOPMENT
-------------	---------------------

-	-
---	---

-	-
---	---

-	-
---	---

-	-
---	---

DRAWING TITLE:

**CHIMELONG PARADE
 CONCEPT DEVELOPMENT
 DIVER**

SHEET NO.

D-C2-04



CONCEPT ARTWORK

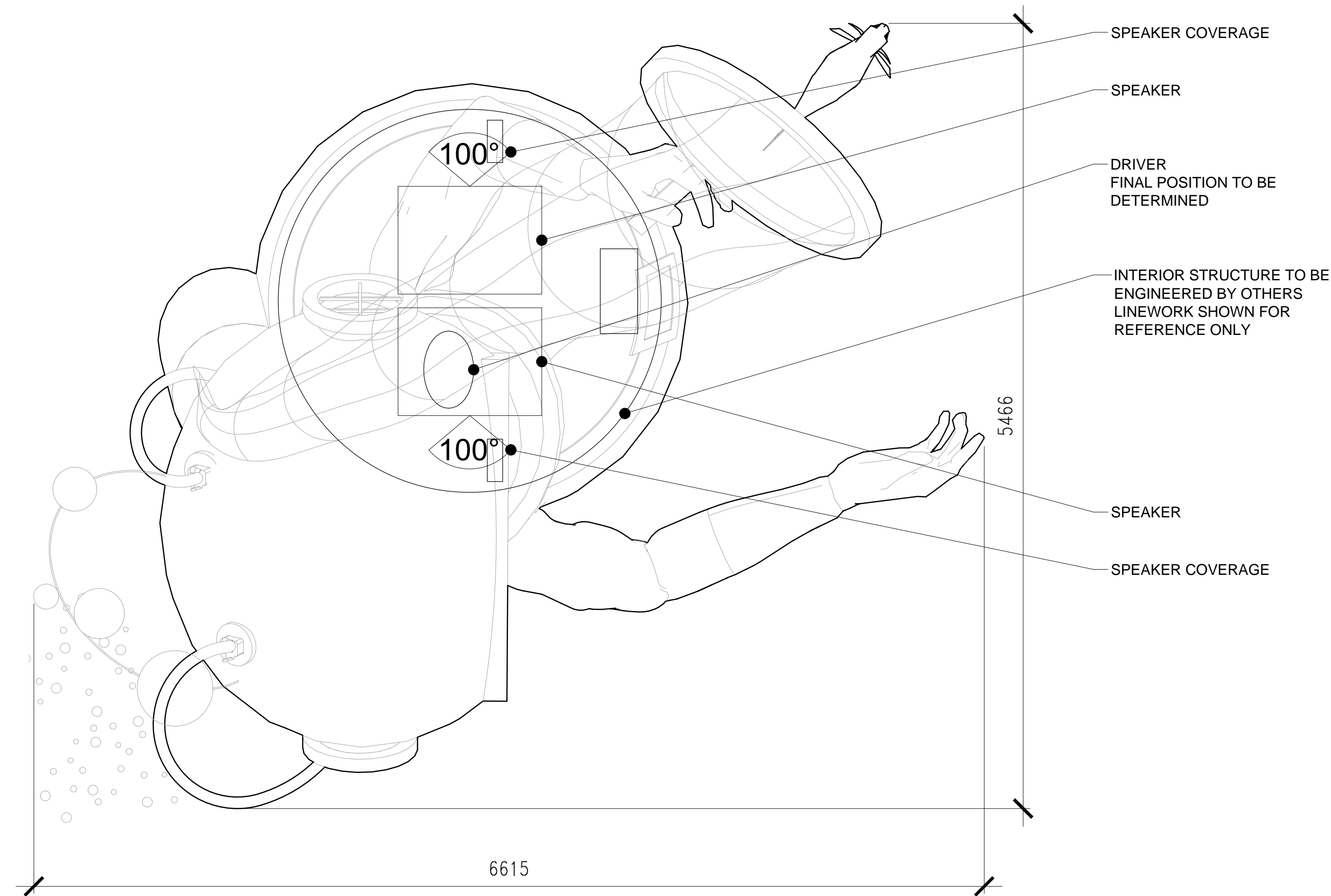

4 CHIMELONG PARADE DIVER PLAN
 1:25

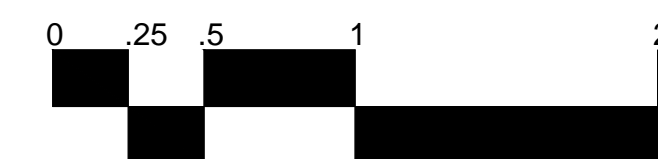

**NOT FOR
 CONSTRUCTION**

NUMBER	ANIMATION or EFFECT	DESCRIPTION OF ANIMATION OR EFFECT	QUANTITY
C3-A	ANIMATION	PERISCOPE - rotates 360 degrees - reactive, joints bobble freely - mechanical/reactive	1
C3-B	ANIMATION	EYEBROWS - up/down animation - mechanical	2
C3-C	ANIMATION	GOOGLY EYES - visible through eye-shaped windows, performer inside cockpit moves levers back and forth to create appearance of "googly" eyes - puppet	2
C3-D	ANIMATION	MOUTH - mouth opens/closes - mechanical	1
C3-E	ANIMATION	TAIL - tail wags left and right - mechanical	1
C3-F	ANIMATION	PROP FISH - leaping animation - mechanical, cam	9
C3-G	EFFECT	BUBBLES - bubbles trail from behind sub tail	1

CUSTOM CHASSIS BY OTHERS

C3-E PIVOT POINT FOR "TAIL" PIECE

WATER AND BUBBLE ELEMENTS TO BE ENGINEERED TO BEAR WEIGHT OF PROP FISH

PROVIDE SEAT FOR DRIVER

C3-E PIVOT POINT FOR "TAIL" PIECE

PROP FISH

WATER AND BUBBLE ELEMENTS TO BE ENGINEERED TO BEAR WEIGHT OF PROP FISH

C3-F BUBBLES FROM BUBBLE MACHINE INSIDE FLOAT

CUSTOM CHASSIS BY OTHERS

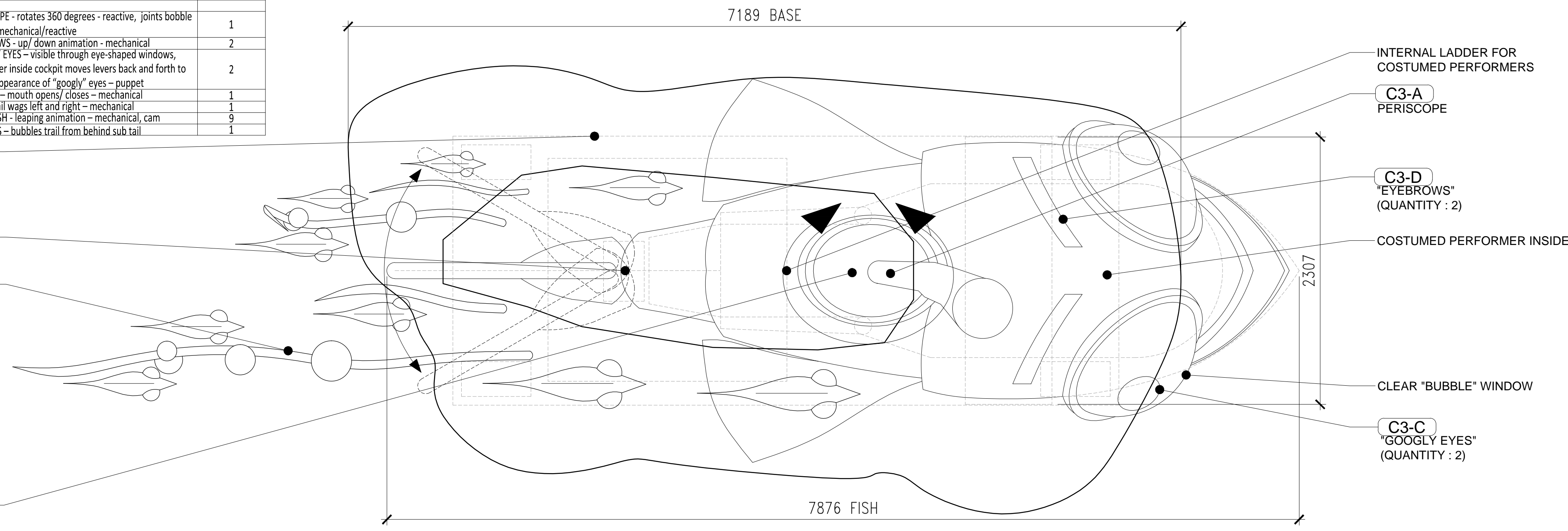

2 CHIMELONG PARADE SUBMARINE PLAN
1:25

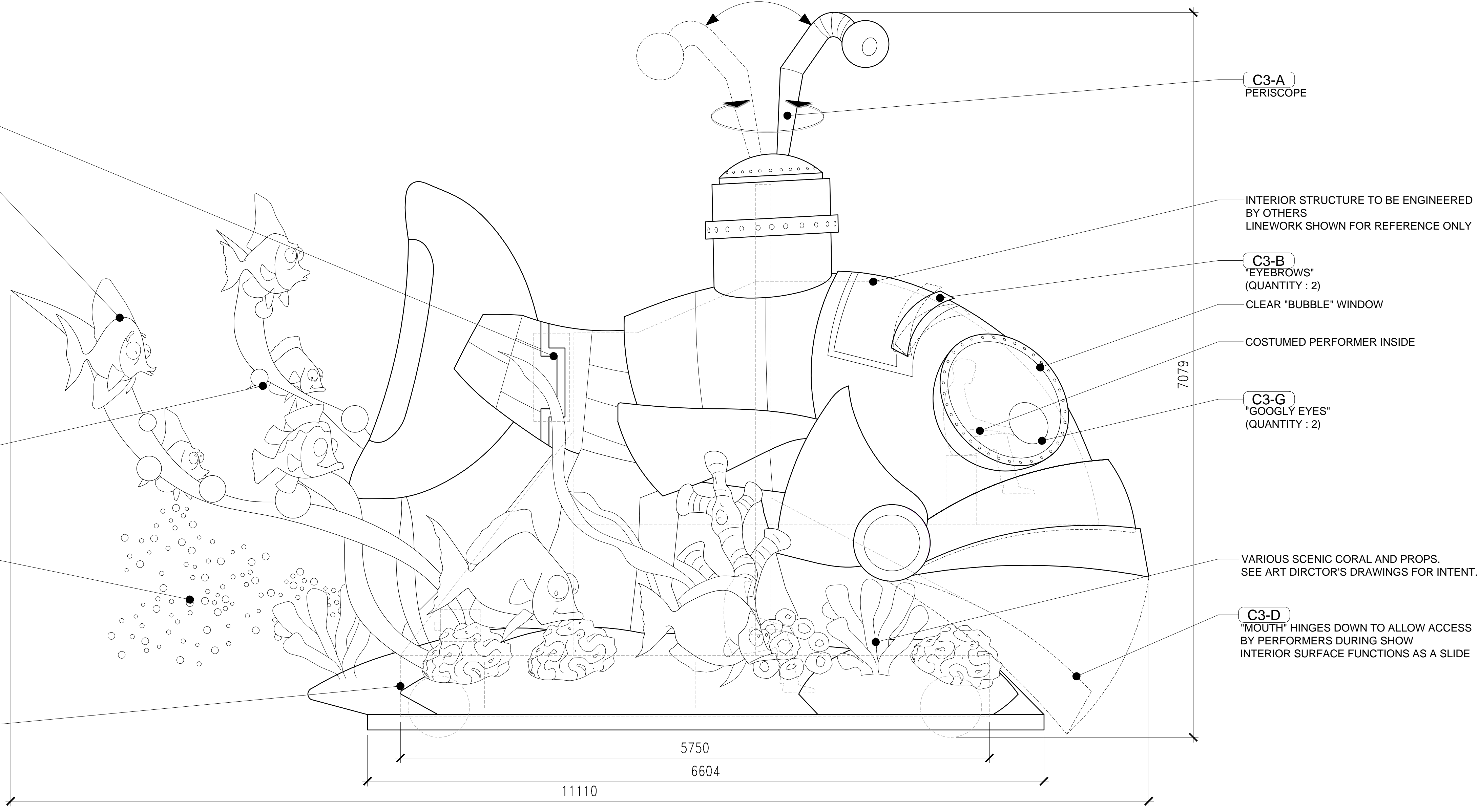

1 CHIMELONG PARADE SUBMARINE ELEVATION
1:25

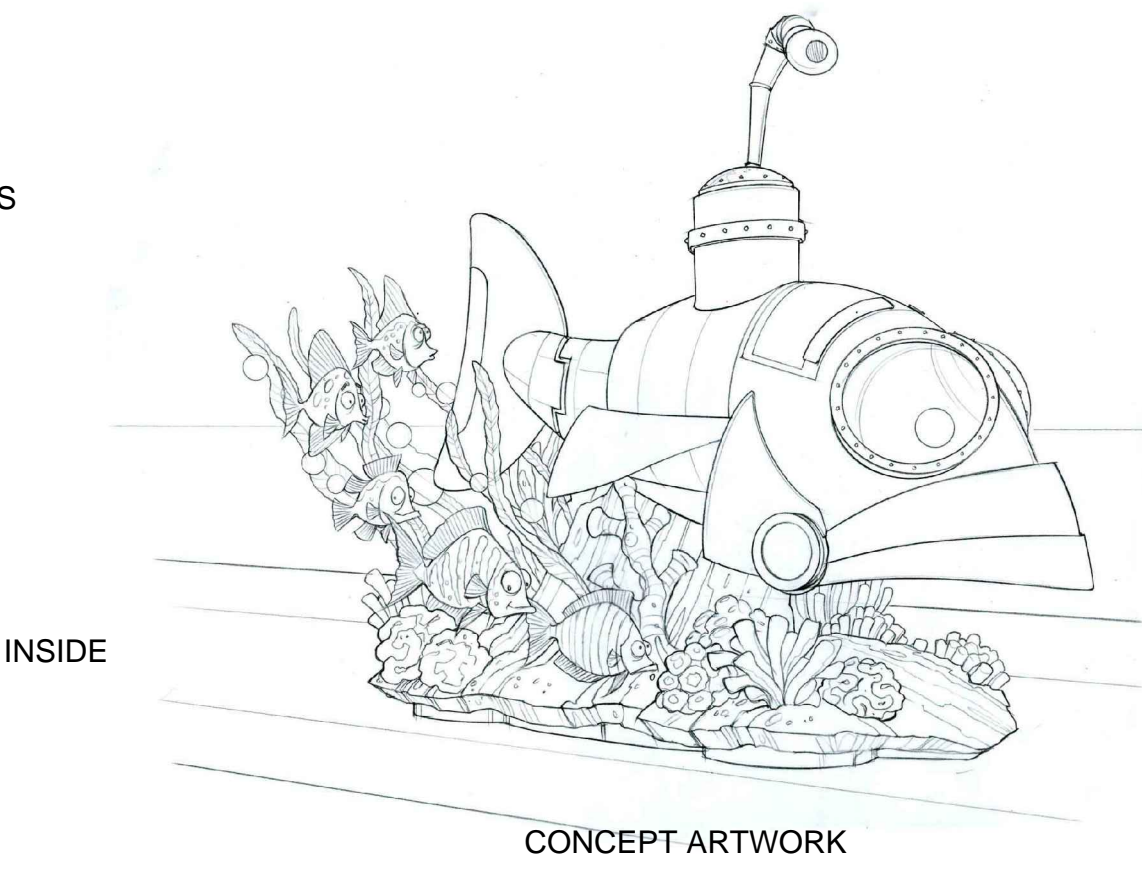

ISSUE DATE	DESCRIPTION
2012/09/10	CONCEPT DESIGN
11-OCT-2012	CONCEPT DEVELOPMENT
-	-
-	-
-	-

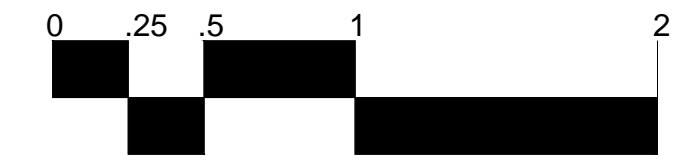

**NOT FOR
CONSTRUCTION**

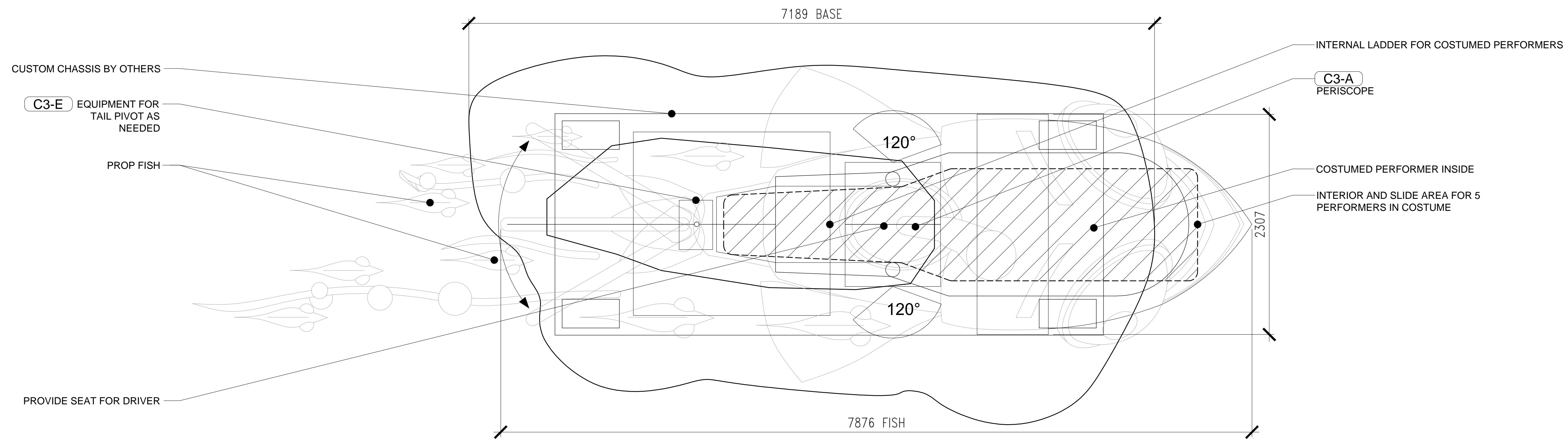

3 CHIMELONG PARADE SUBMARINE PLAN
1:25

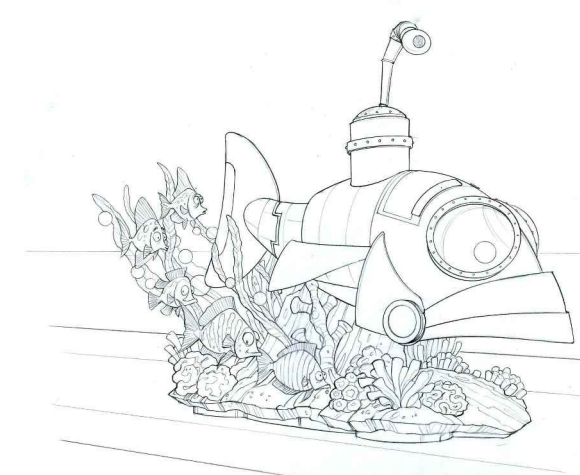

CONCEPT ARTWORK

ISSUE DATE	DESCRIPTION
2012/09/10	CONCEPT DESIGN
11-OCT-2012	CONCEPT DEVELOPMENT
-	-
-	-
-	-

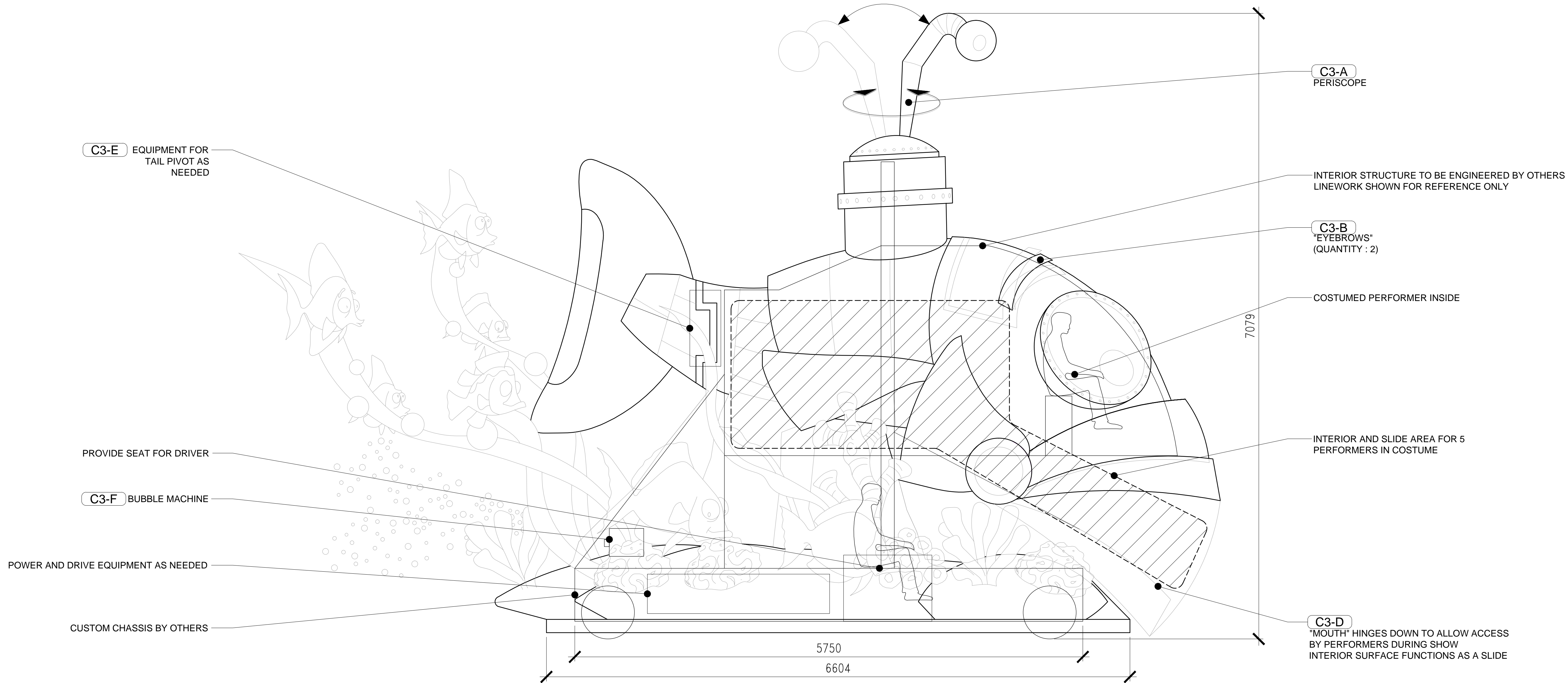

4 CHIMELONG PARADE SUBMARINE ELEVATION
1:25

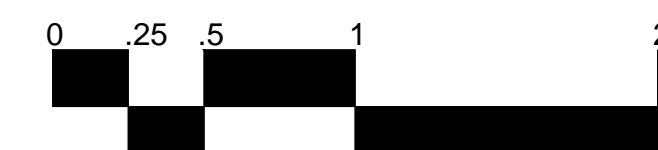

KEYPLAN

NOT FOR CONSTRUCTION

NUMBER	ANIMATION or EFFECT	DESCRIPTION OF ANIMATION OR EFFECT	QUANTITY
C4-A	ANIMATION	EYES - irises rotate - mechanical	2
C4-B	ANIMATION	MOUTH - mouth opens/ closes - puppet	1

INTERIOR STRUCTURE TO BE ENGINEERED BY OTHERS
LINEWORK SHOWN FOR REFERENCE ONLY

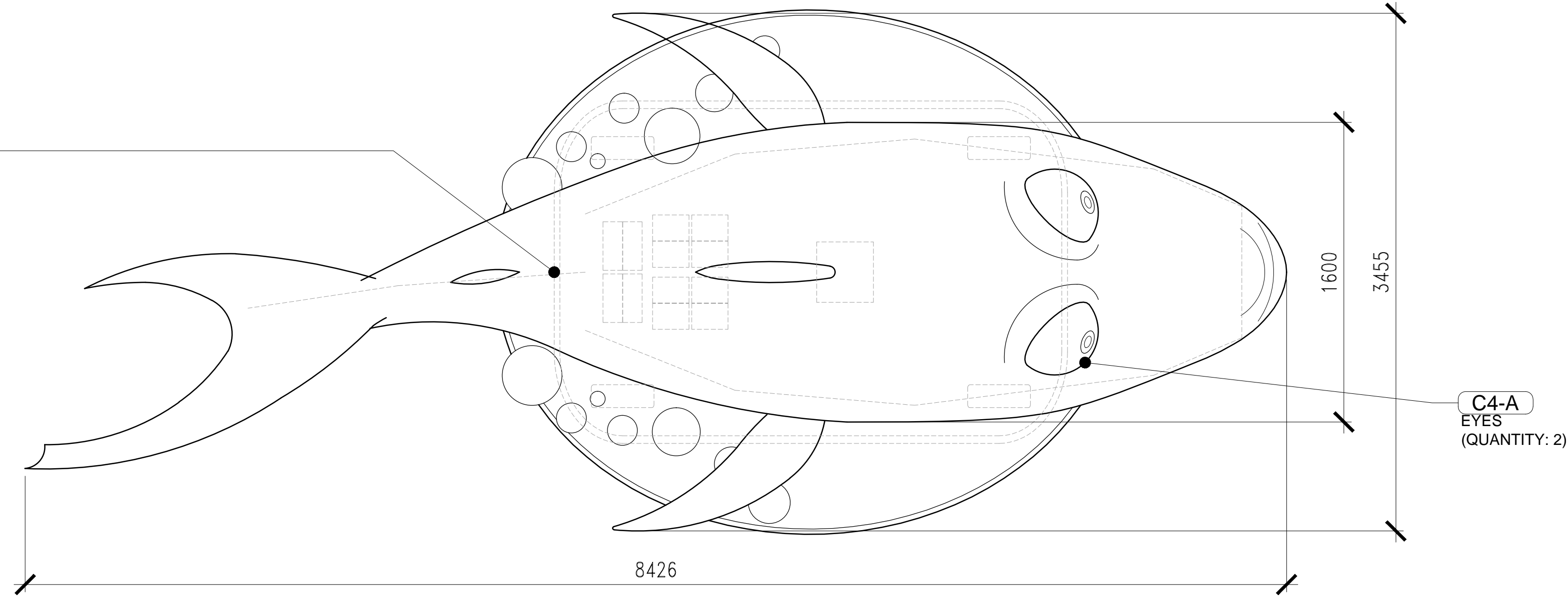

2 CHIMELONG PARADE SILLY SHARK PLAN
1:25

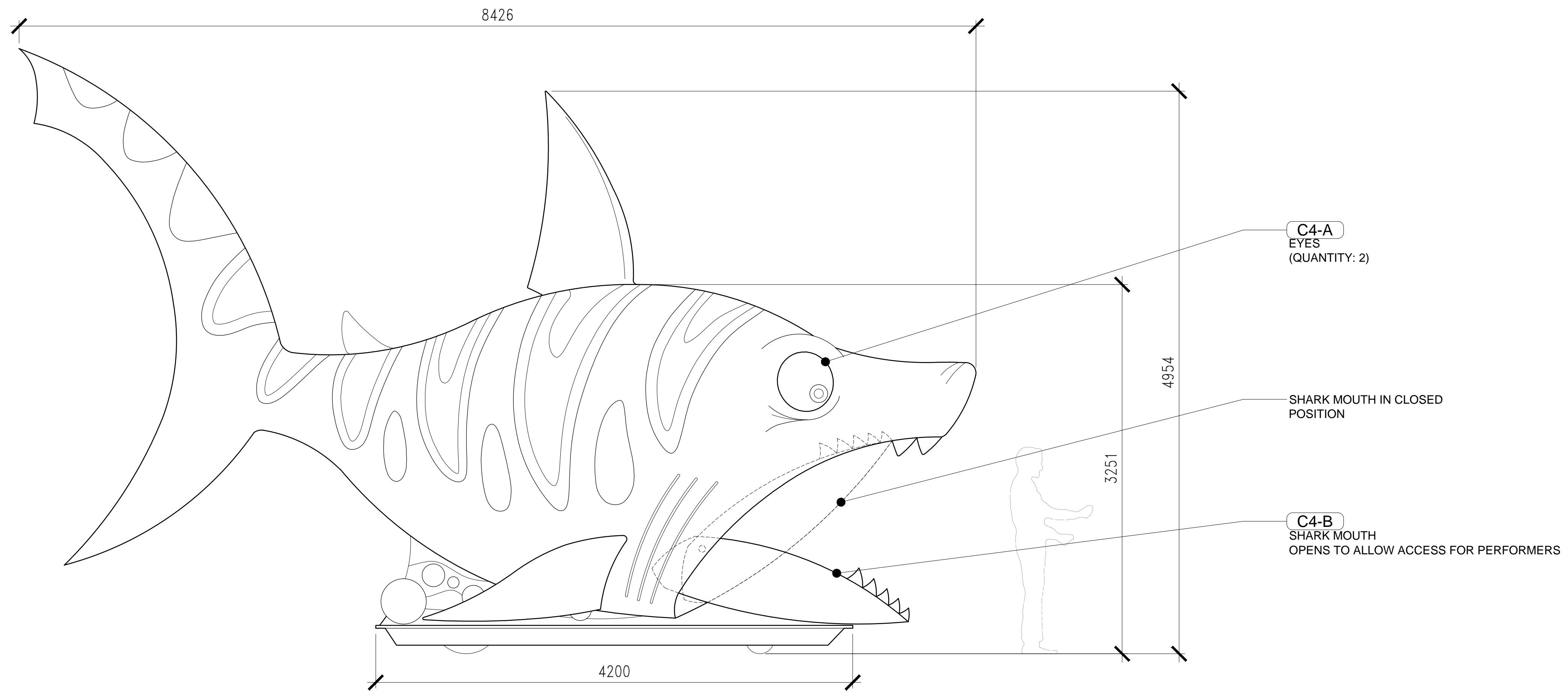

1 CHIMELONG PARADE SILLY SHARK ELEVATION
1:25

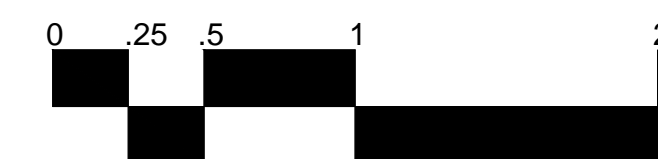

NOT FOR CONSTRUCTION

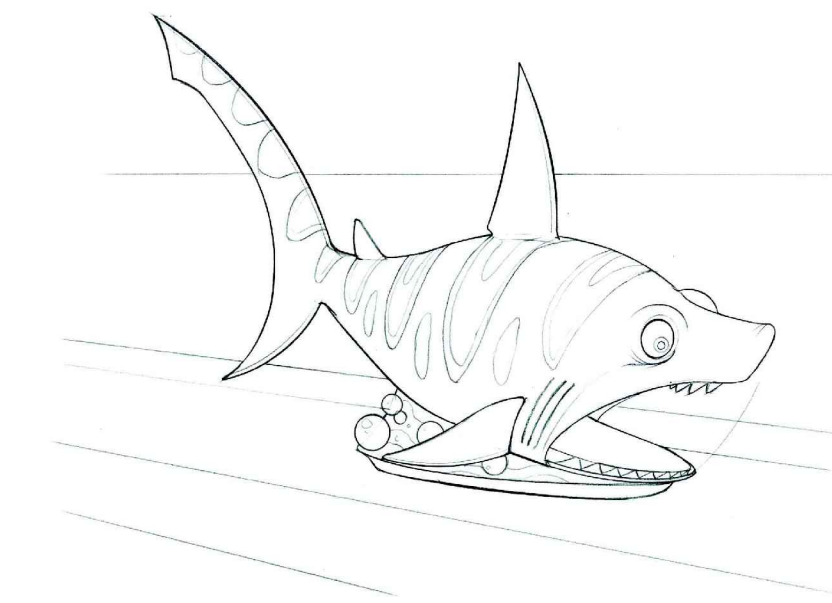

CONCEPT ARTWORK

PROJECT:

HENQIN OCEAN KINGDOM

CLIENT:

Zhuhai Chimelong Investment and Development Co., Ltd.
Chimelong Office G1,
Fuxiang Bay, Hengqin New District
Zhuhai 519031, People's Republic of China

CONSULTANT:

NOTICES:
THESE PARADE DESIGN DOCUMENTS ARE FOR DESIGN INTENT PURPOSE ONLY AND NOT FOR CONSTRUCTION.

ANY PROJECT ARCHITECTURAL DESIGN, ENGINEERING, CONSTRUCTION, COMMISSIONING, AND COMPLIANCE WITH LOCAL LIFE SAFETY AND BUILDING CODES SHALL BE PROVIDED AND PERFORMED BY LOCALLY LICENSED PROFESSIONALS.

THE DATA IN THIS DOCUMENT INCORPORATE PROPRIETARY RIGHTS OF THE HETEMA GROUP, 67 VALLEY STREET PASADENA, CA 91105. ANY PARTY ACCEPTING THIS DOCUMENT DOES SO IN CONFIDENCE AND AGREES THAT IT SHALL NOT BE DUPLICATED, IN WHOLE OR IN PART, OR BE DISCLOSED TO OTHERS, WITHOUT THE PRIOR WRITTEN CONSENT OF THE HETEMA GROUP, INC.

AND
ZHUHAI CHIMELONG INVESTMENT AND DEVELOPMENT CO., LTD.
CHIMELONG OFFICE G1,
FUXIANG BAY, HENQIN NEW DISTRICT
ZHUHAI 519031, PEOPLE'S REPUBLIC OF CHINA

**FINAL DESIGN
PACKAGE UPDATE
PROGRESS PLOT**

ISSUE DATE	DESCRIPTION
2012/09/10	CONCEPT DESIGN
11-OCT-2012	CONCEPT DEVELOPMENT
-	-
-	-
-	-

DRAWING TITLE:
**CHIMELONG PARADE
CONCEPT DEVELOPMENT
SILLY SHARK**

SHEET NO.

D-C4-01

PROJECT:

HENQIN OCEAN KINGDOM

CLIENT:

Zhuhai Chimelong Investment and Development Co., Ltd.
 Chimelong Office G1,
 Fuxiang Bay, Hengqin New District
 Zhuhai 519031, People's Republic of China

CONSULTANT:

NOTICES:
 THESE PARADE DESIGN DOCUMENTS ARE FOR DESIGN INTENT PURPOSE ONLY AND NOT FOR CONSTRUCTION.

ANY PROJECT ARCHITECTURAL DESIGN, ENGINEERING, CONSTRUCTION, COMMISSIONING, AND COMPLIANCE WITH LOCAL LIFE SAFETY AND BUILDING CODES SHALL BE PROVIDED AND PERFORMED BY LOCALLY LICENSED PROFESSIONALS.

THE DATA IN THIS DOCUMENT INCORPORATE PROPRIETARY RIGHTS OF THE HETEMA GROUP, 67 VALLEY STREET PASADENA, CA 91105. ANY PARTY ACCEPTING THIS DOCUMENT DOES SO IN CONFIDENCE AND AGREES THAT IT SHALL NOT BE DUPLICATED, IN WHOLE OR IN PART, OR BE DISCLOSED TO OTHERS, WITHOUT THE PRIOR WRITTEN CONSENT OF THE HETEMA GROUP, INC. AND ZHUHAI CHIMELONG INVESTMENT AND DEVELOPMENT CO., LTD. CHIMELONG OFFICE G1, FUXIANG BAY, HENQIN NEW DISTRICT ZHUHAI 519031, PEOPLE'S REPUBLIC OF CHINA

FINAL DESIGN
 PACKAGE UPDATE
 PROGRESS PLOT

ISSUE DATE	DESCRIPTION
2012/09/10	CONCEPT DESIGN
11-OCT-2012	CONCEPT DEVELOPMENT
-	-
-	-
-	-

DRAWING TITLE:
 CHIMELONG PARADE
 CONCEPT DEVELOPMENT
 SILLY SHARK

SHEET NO.

D-C4-02

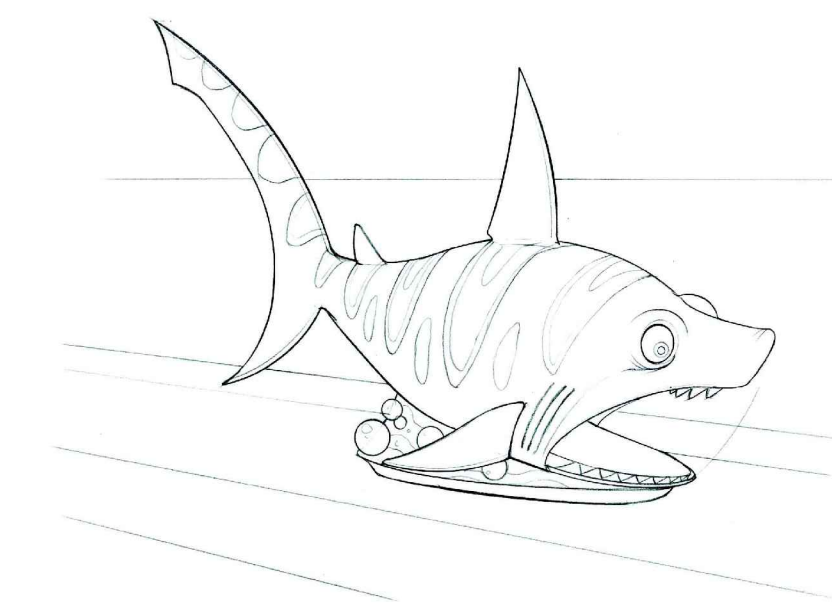

CONCEPT ARTWORK

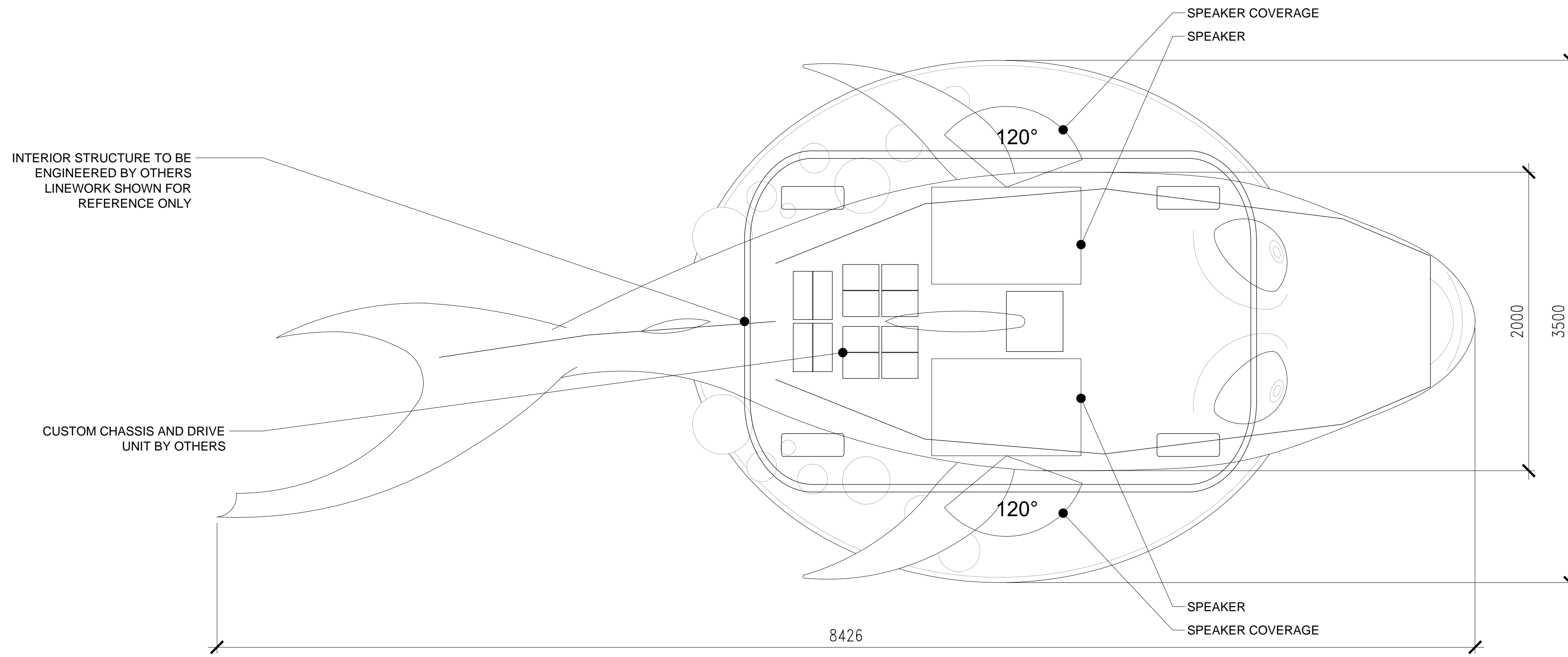

4 CHIMELONG PARADE SILLY SHARK PLAN
 1:25

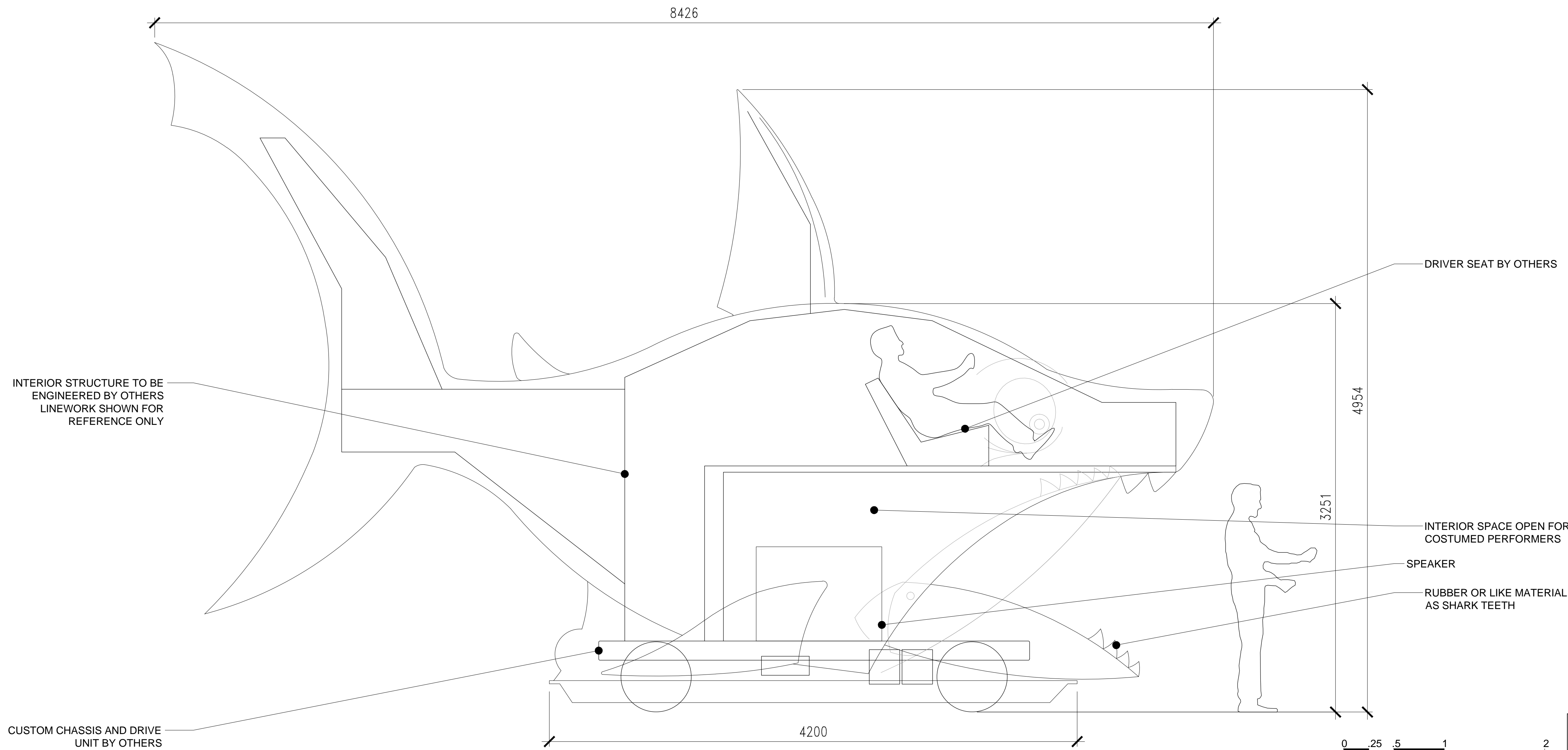

3 CHIMELONG PARADE SILLY SHARK ELEVATION
 1:25

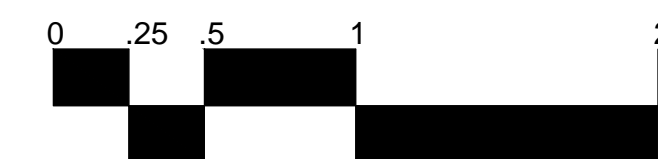

NOT FOR
 CONSTRUCTION

NUMBER	ANIMATION or EFFECT	DESCRIPTION OF ANIMATION OR EFFECT	QUANTITY
C5-A	ANIMATION	EYELIDS - eyelids open/ close on timer - mechanical	2
C5-B	ANIMATION	EYES - eyes left/ right, tied to float base turning so eyes lead the body's movement - mechanical	2
C5-C	ANIMATION	MOUTH - mouth opens/ closes - puppet	1
C5-D	ANIMATION	FLIPPERS - "swimming" action - puppet	2
C5-E	ANIMATION	HEAD/ NECK - head left/ right, neck crane - puppet	1
C5-F	ANIMATION	BODY - body pivot - puppet	1

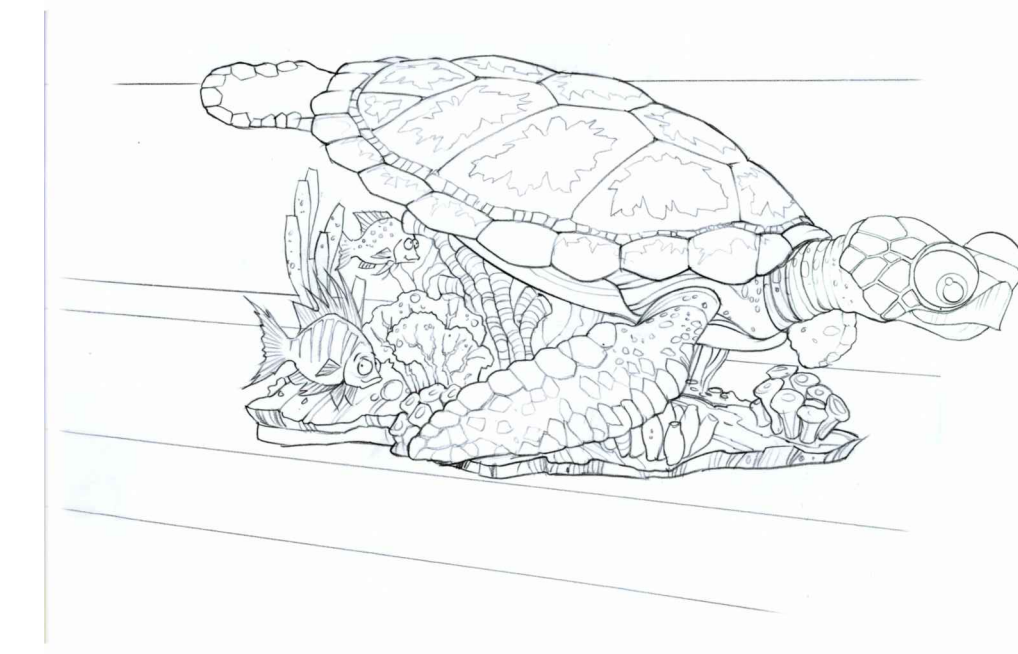
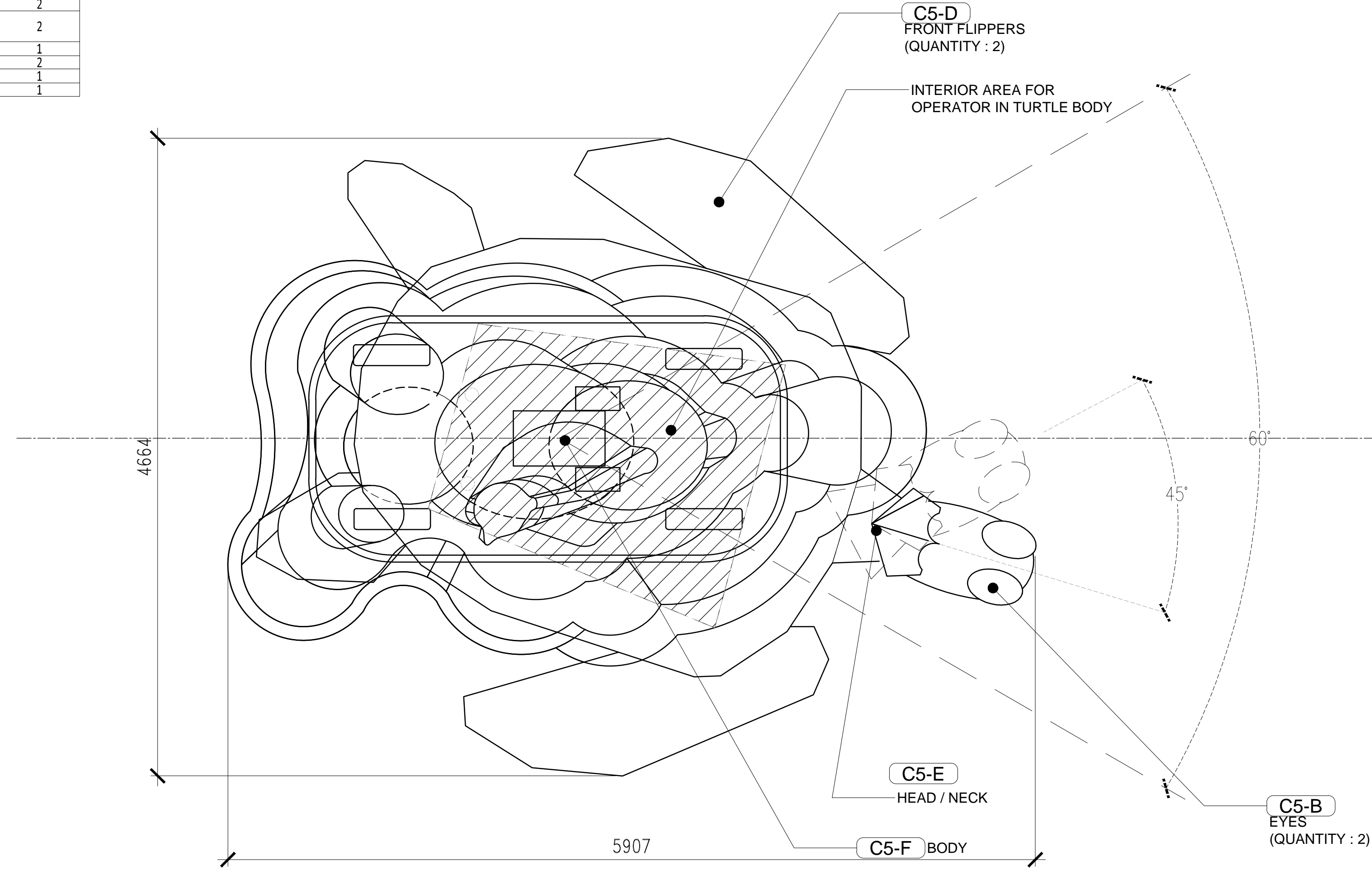

CONCEPT ARTWORK

2 CHIMELONG PARADE LARGE TURTLE PLAN
1:25

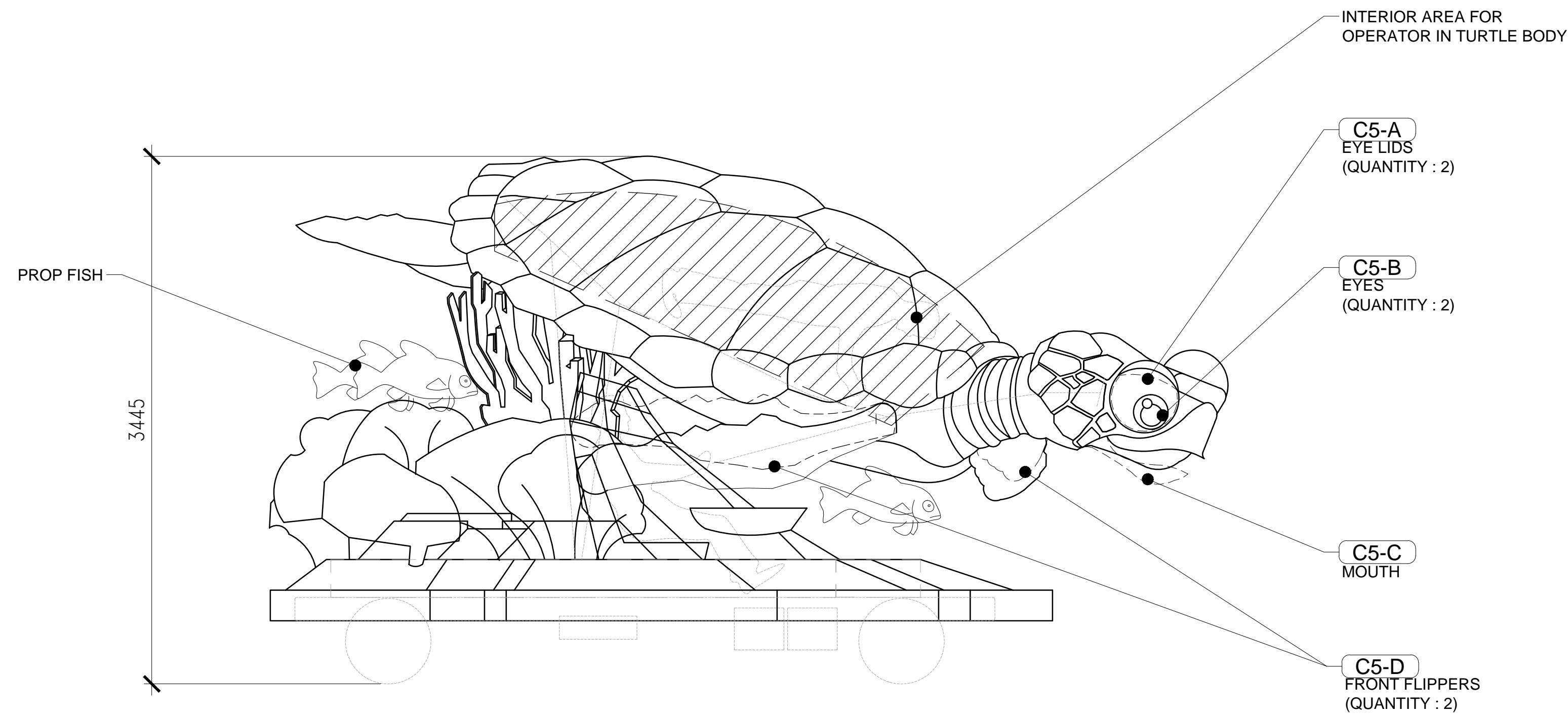

1 CHIMELONG PARADE LARGE TURTLE ELEVATION
1:25

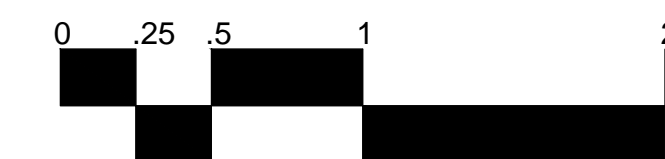

NOT FOR CONSTRUCTION

PROJECT:

HENQIN OCEAN KINGDOM

CLIENT:

Zhuhai Chimelong Investment and Development Co., Ltd.
Chimelong Office G1,
Fuxiang Bay, Hengqin New District
Zhuhai 519031, People's Republic of China

CONSULTANT:

NOTICES:
THESE PARADE DESIGN DOCUMENTS ARE FOR DESIGN INTENT PURPOSE ONLY AND NOT FOR CONSTRUCTION.

ANY PROJECT ARCHITECTURAL DESIGN, ENGINEERING, CONSTRUCTION, COMMISSIONING, AND COMPLIANCE WITH LOCAL LIFE SAFETY AND BUILDING CODES SHALL BE PROVIDED AND PERFORMED BY LOCALLY LICENSED PROFESSIONALS.

THE DATA IN THIS DOCUMENT INCORPORATE PROPRIETARY RIGHTS OF THE HETTEMA GROUP, 67 VALLEY STREET PASADENA, CA 91105. ANY PARTY ACCEPTING THIS DOCUMENT DOES SO IN CONFIDENCE AND AGREES THAT IT SHALL NOT BE DUPLICATED, IN WHOLE OR IN PART, OR BE DISCLOSED TO OTHERS, WITHOUT THE PRIOR WRITTEN CONSENT OF THE HETTEMA GROUP, INC. AND
ZHUHAI CHIMELONG INVESTMENT AND DEVELOPMENT CO., LTD. CHIMELONG OFFICE G1, FUXIANG BAY, HENQIN NEW DISTRICT, ZHUHAI 519031, PEOPLE'S REPUBLIC OF CHINA

FINAL DESIGN PACKAGE UPDATE PROGRESS PLOT

ISSUE DATE	DESCRIPTION
2012/09/10	CONCEPT DESIGN
11-OCT-2012	CONCEPT DEVELOPMENT
-	-
-	-
-	-

DRAWING TITLE:

CHIMELONG PARADE CONCEPT DEVELOPMENT LARGE TURTLE

SHEET NO.

D-C5-01

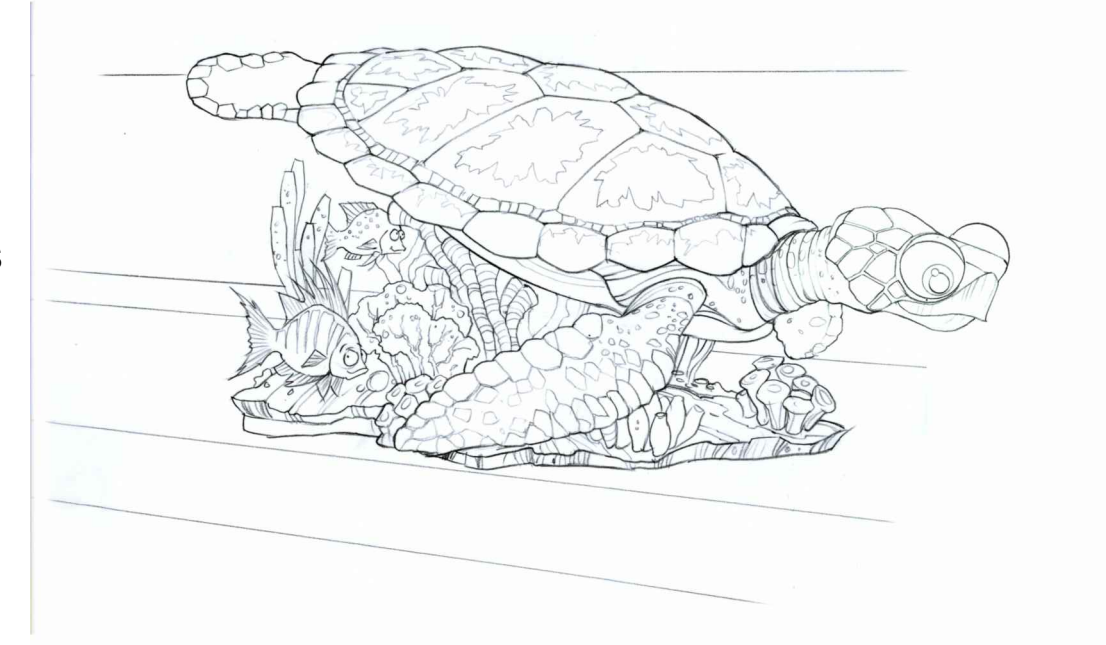
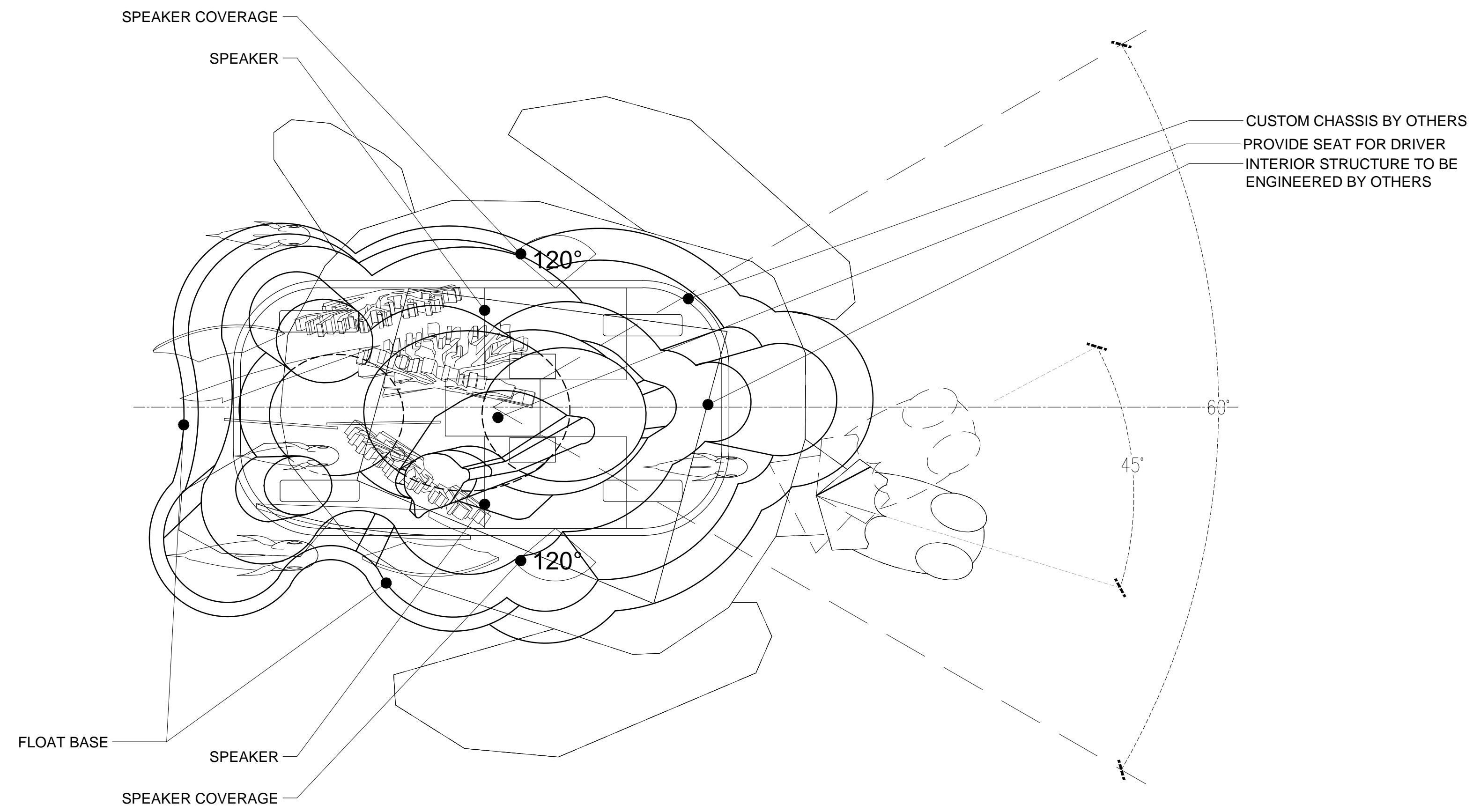

4 CHIMELONG PARADE LARGE TURTLE PLAN
1:25

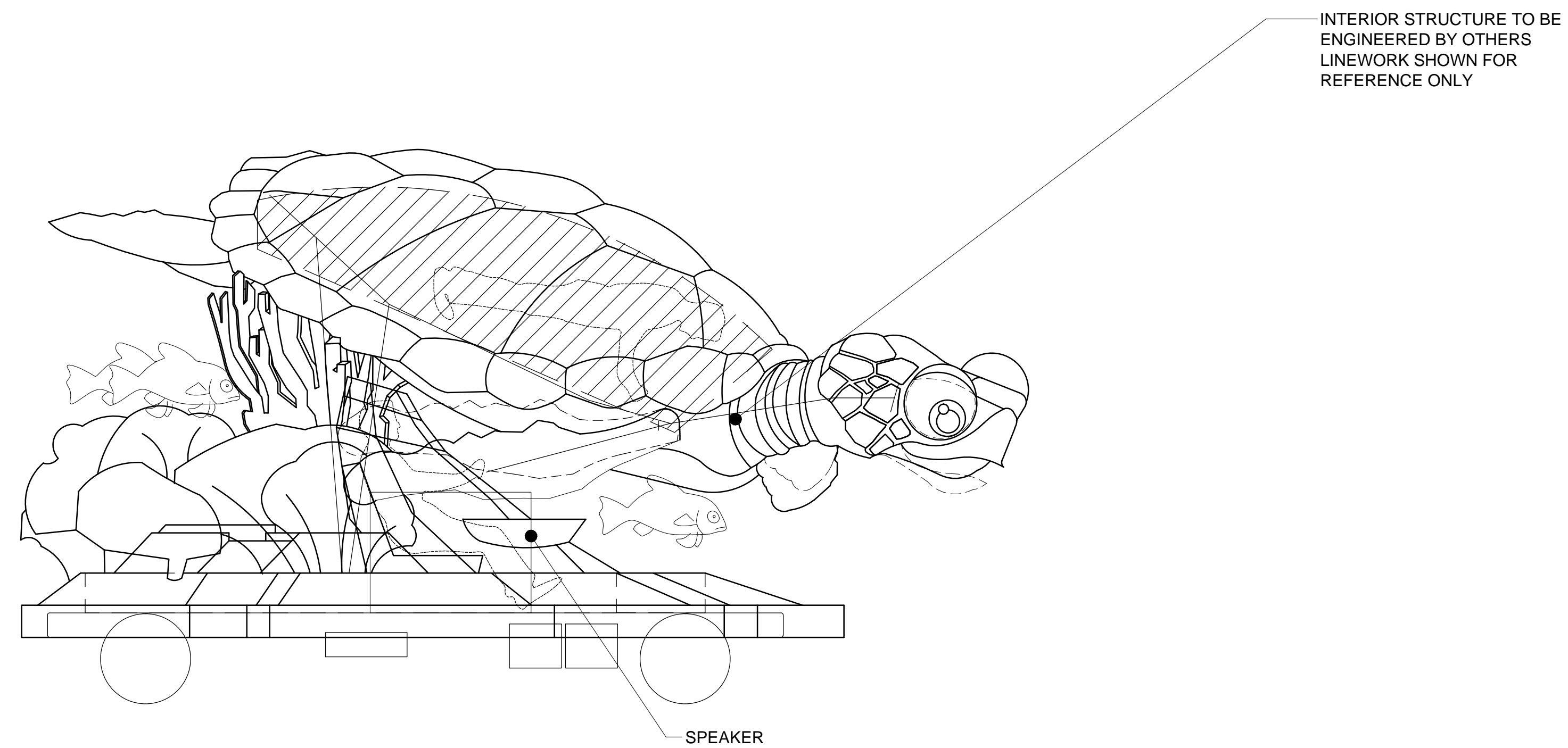

3 CHIMELONG PARADE LARGE TURTLE ELEVATION
1:25

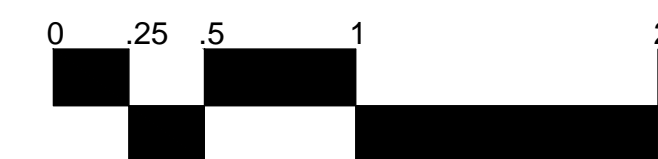

NOT FOR CONSTRUCTION

PROJECT:

HENQIN OCEAN KINGDOM

CLIENT:

Zhuhai Chimelong Investment and Development Co., Ltd.
Chimelong Office G1,
Fuxiang Bay, Hengqin New District
Zhuhai 519031, People's Republic of China

CONSULTANT:

NOTICES:
THESE PARADE DESIGN DOCUMENTS ARE FOR DESIGN INTENT PURPOSE ONLY AND NOT FOR CONSTRUCTION.

ANY PROJECT ARCHITECTURAL DESIGN, ENGINEERING, CONSTRUCTION, COMMISSIONING, AND COMPLIANCE WITH LOCAL LIFE SAFETY AND BUILDING CODES SHALL BE PROVIDED AND PERFORMED BY LOCALLY LICENSED PROFESSIONALS.

THE DATA IN THIS DOCUMENT INCORPORATE PROPRIETARY RIGHTS OF THE HETTEMA GROUP, 67 VALLEY STREET PASADENA, CA 91105. ANY PARTY ACCEPTING THIS DOCUMENT DOES SO IN CONFIDENCE AND AGREES THAT IT SHALL NOT BE DUPLICATED, IN WHOLE OR IN PART, OR BE DISCLOSED TO OTHERS, WITHOUT THE PRIOR WRITTEN CONSENT OF THE HETTEMA GROUP, INC. AND
ZHUHAI CHIMELONG INVESTMENT AND DEVELOPMENT CO., LTD.
CHIMELONG OFFICE G1,
FUXIANG BAY, HENQIN NEW DISTRICT
ZHUHAI 519031, PEOPLE'S REPUBLIC OF CHINA

FINAL DESIGN PACKAGE UPDATE PROGRESS PLOT

ISSUE DATE	DESCRIPTION
2012/09/10	CONCEPT DESIGN
11-OCT-2012	CONCEPT DEVELOPMENT

DRAWING TITLE:
CHIMELONG PARADE CONCEPT DEVELOPMENT LARGE TURTLE

SHEET NO.

D-C5-02

NUMBER	ANIMATION or EFFECT	DESCRIPTION OF ANIMATION OR EFFECT	QUANTITY
D1-A	ANIMATION	HEAD - head turn left/right - puppet	1
D1-B	ANIMATION	MOUTH - mouth open/close - puppet	1
D1-C	ANIMATION	BODY - body sway, squash/stretch animation - puppet	1
D1-D	ANIMATION	FLIPPERS - up/down "flapping" action - puppet	2
D1-E	ANIMATION	BODY RISE - body rears up on hind flippers - puppet	1

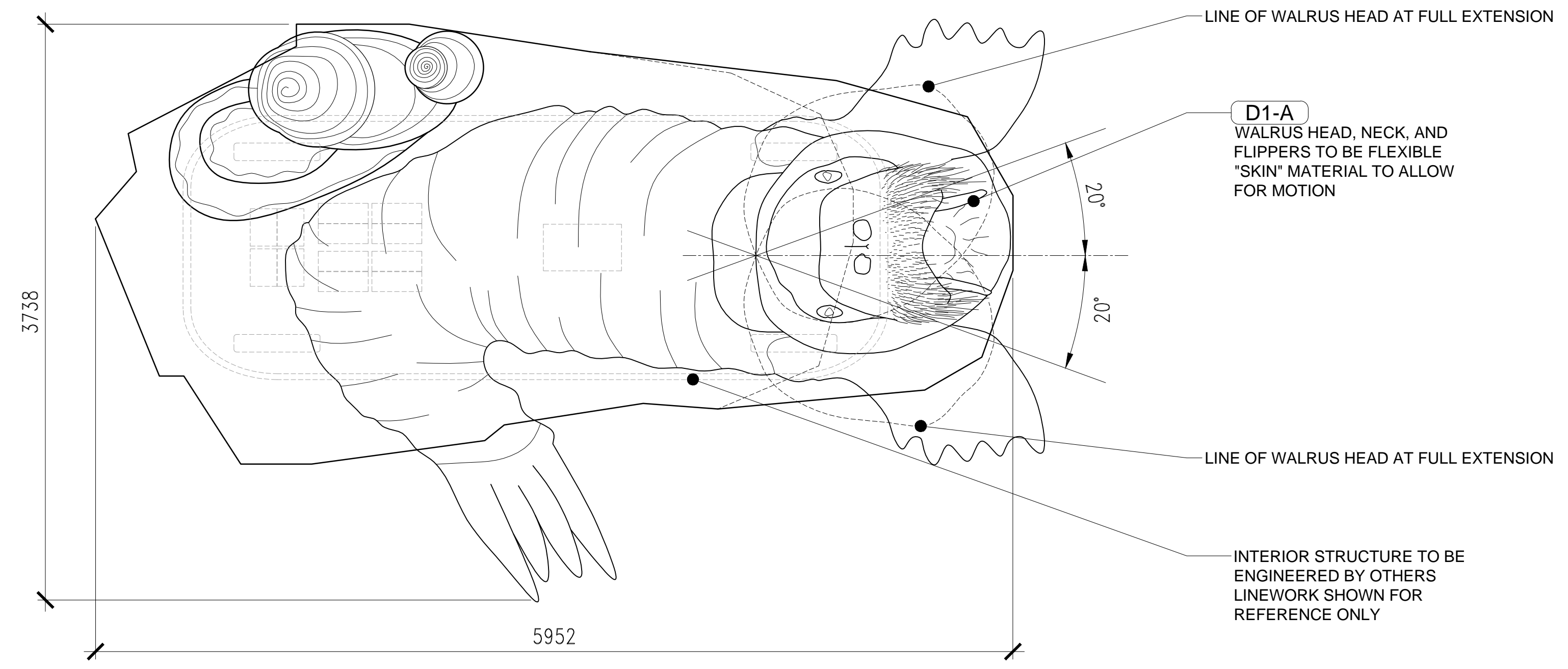

2 CHIMELONG PARADE WALRUS PLAN
1:25

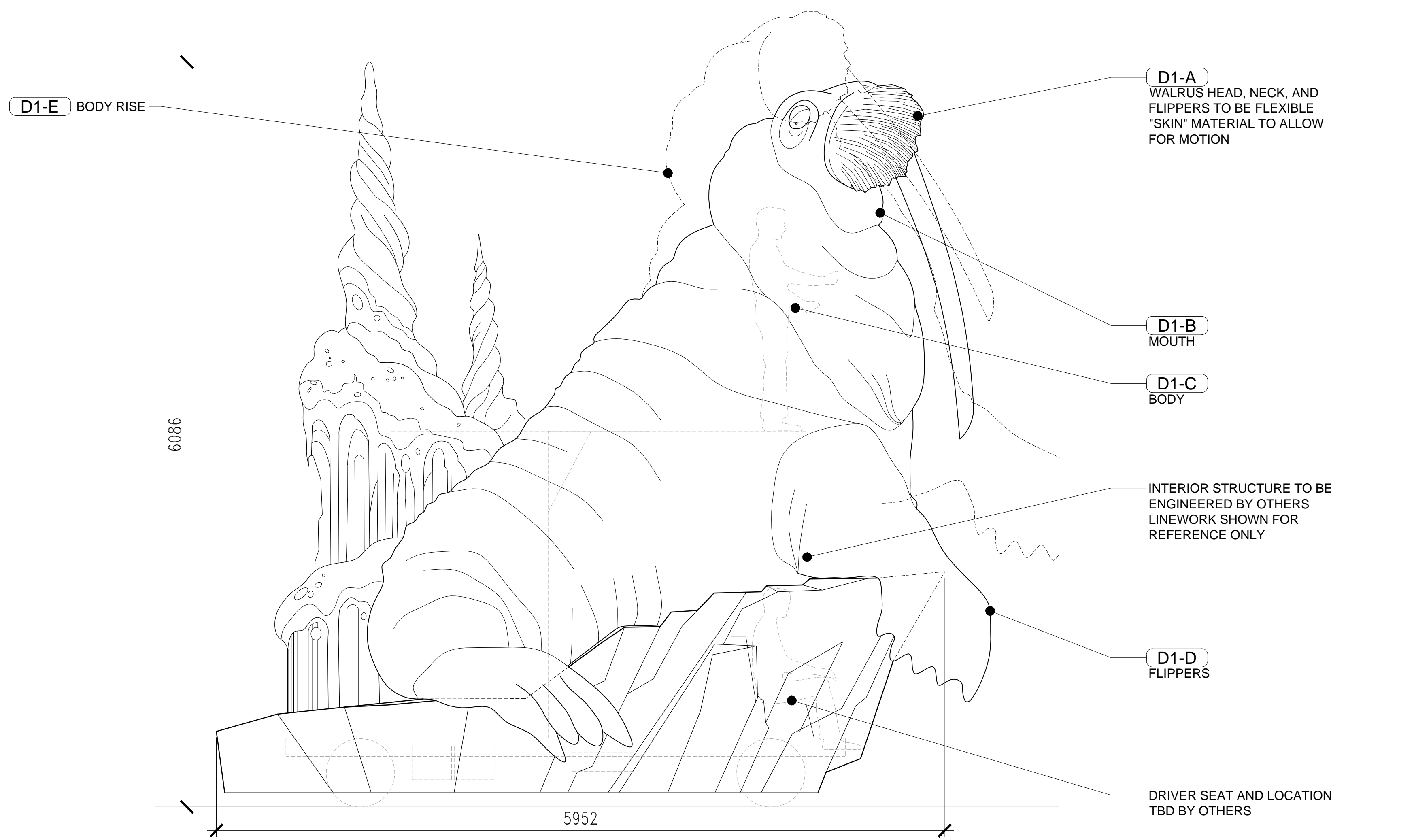

1 CHIMELONG PARADE WALRUS ELEVATION
1:25



CONCEPT ARTWORK

PROJECT:
HENQIN OCEAN KINGDOM

CLIENT:
Zhuhai Chimelong Investment and Development Co., Ltd.
Chimelong Office G1,
Fuxiang Bay, Hengqin New District
Zhuhai 519031, People's Republic of China

CONSULTANT:

NOTICES:
THESE PARADE DESIGN DOCUMENTS ARE FOR DESIGN INTENT PURPOSE ONLY AND NOT FOR CONSTRUCTION.
ANY PROJECT ARCHITECTURAL DESIGN, ENGINEERING, CONSTRUCTION, COMMISSIONING, AND COMPLIANCE WITH LOCAL LIFE SAFETY AND BUILDING CODES SHALL BE PROVIDED AND PERFORMED BY LOCALLY LICENSED PROFESSIONALS.
THE DATA IN THIS DOCUMENT INCORPORATE PROPRIETARY RIGHTS OF THE HETEMA GROUP, 67 VALLEY STREET PASADENA, CA 91105. ANY PARTY ACCEPTING THIS DOCUMENT DOES SO IN CONFIDENCE AND AGREES THAT IT SHALL NOT BE DUPLICATED, IN WHOLE OR IN PART, OR BE DISCLOSED TO OTHERS, WITHOUT THE PRIOR WRITTEN CONSENT OF THE HETEMA GROUP, INC. AND ZHUHAI CHIMELONG INVESTMENT AND DEVELOPMENT CO., LTD. CHIMELONG OFFICE G1, FUXIANG BAY, HENQIN NEW DISTRICT ZHUHAI 519031, PEOPLE'S REPUBLIC OF CHINA

FINAL DESIGN PACKAGE UPDATE PROGRESS PLOT

ISSUE DATE	DESCRIPTION
2012/09/00	BASELINE DESIGN
11-OCT-2012	CONCEPT DEVELOPMENT
-	-
-	-
-	-

DRAWING TITLE:
CHIMELONG PARADE CONCEPT DEVELOPMENT WALRUS

SHEET NO.
D-D1-01

PROJECT:

HENQIN OCEAN KINGDOM

CLIENT:

Zhuhai Chimelong Investment and Development Co., Ltd.
 Chimelong Office G1,
 Fuxiang Bay, Hengqin New District
 Zhuhai 519031, People's Republic of China

CONSULTANT:

NOTICES:
 THESE PARADE DESIGN DOCUMENTS ARE FOR DESIGN INTENT PURPOSE ONLY AND NOT FOR CONSTRUCTION.

ANY PROJECT ARCHITECTURAL DESIGN, ENGINEERING, CONSTRUCTION, COMMISSIONING, AND COMPLIANCE WITH LOCAL LIFE SAFETY AND BUILDING CODES SHALL BE PROVIDED AND PERFORMED BY LOCALLY LICENSED PROFESSIONALS.

THE DATA IN THIS DOCUMENT INCORPORATE PROPRIETARY RIGHTS OF THE HETEMA GROUP, 67 VALLEY STREET PASADENA, CA 91105. ANY PARTY ACCEPTING THIS DOCUMENT DOES SO IN CONFIDENCE AND AGREES THAT IT SHALL NOT BE DUPLICATED, IN WHOLE OR IN PART, OR BE DISCLOSED TO OTHERS, WITHOUT THE PRIOR WRITTEN CONSENT OF THE HETEMA GROUP, INC. AND ZHUHAI CHIMELONG INVESTMENT AND DEVELOPMENT CO., LTD. CHIMELONG OFFICE G1, FUXIANG BAY, HENQIN NEW DISTRICT ZHUHAI 519031, PEOPLE'S REPUBLIC OF CHINA

FINAL DESIGN
 PACKAGE UPDATE
 PROGRESS PLOT

ISSUE DATE	DESCRIPTION
------------	-------------

2012/09/10	CONCEPT DESIGN
11-OCT-2012	CONCEPT DEVELOPMENT

-	-
-	-
-	-

DRAWING TITLE:

CHIMELONG PARADE
 CONCEPT DEVELOPMENT
 WALRUS

SHEET NO.

D-D1-02



CONCEPT ARTWORK

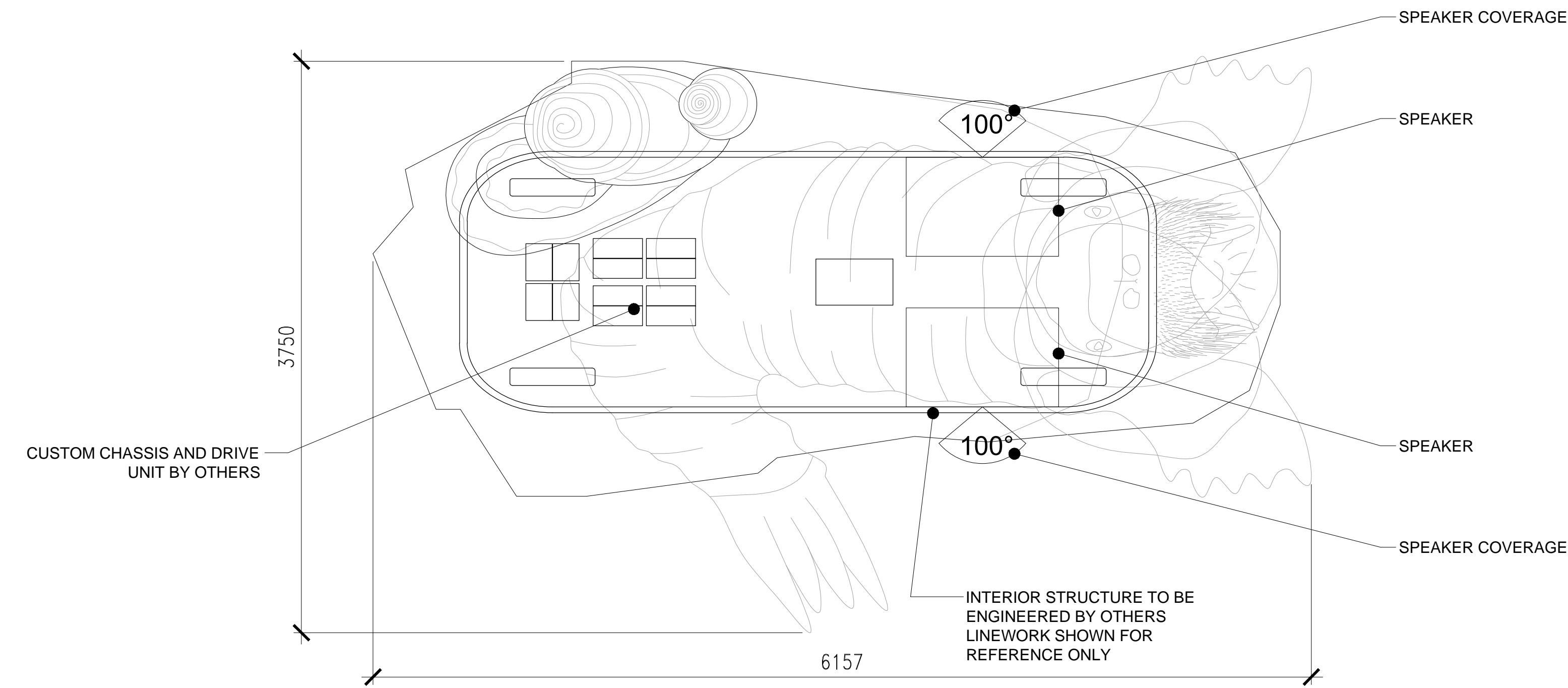

4 CHIMELONG PARADE WALRUS PLAN
 1:25

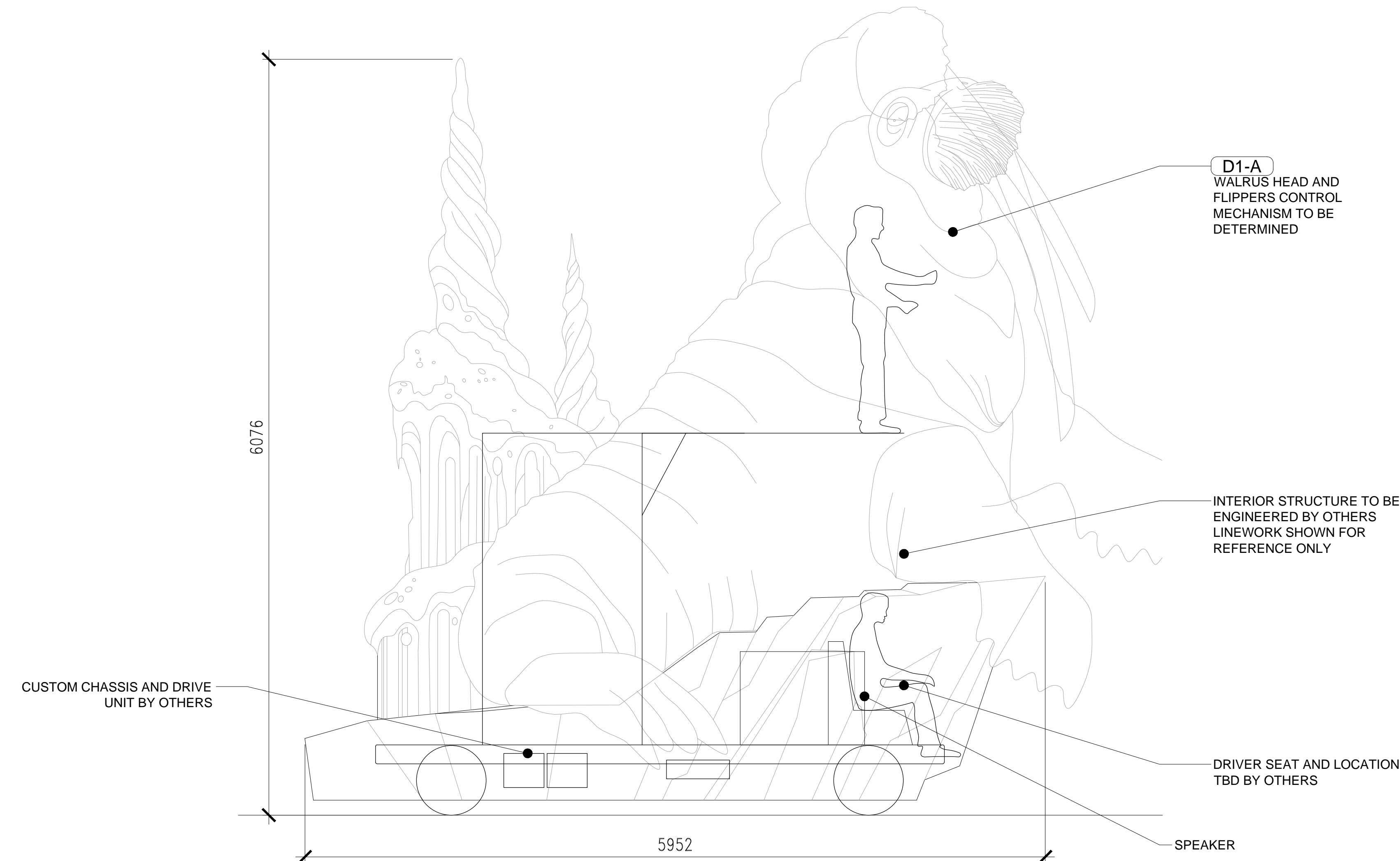

3 CHIMELONG PARADE WALRUS ELEVATION
 1:25

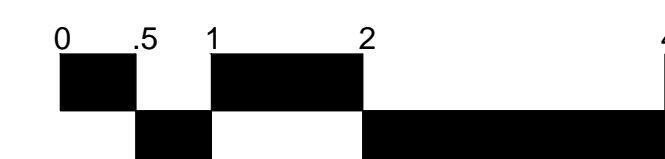

NOT FOR
 CONSTRUCTION

NUMBER	ANIMATION or EFFECT	DESCRIPTION OF ANIMATION OR EFFECT	QUANTITY
		NOTE: PENGUIN FIGURE ANIMATION/PLACEMENT TO BE DETERMINED IN PRODUCTION	
D2	ANIMATION	PENGUIN SPINNER 1 – penguin figure spins on ice chunk – mechanical	1
D2	ANIMATION	PENGUIN SPINNER 2 – penguin figure spins on ice chunk – mechanical	1
D2	ANIMATION	PENGUIN SPINNER 3 – penguin figure spins on ice chunk – mechanical	1
D2	ANIMATION	PENGUIN SLIDER – penguin figure on turntable, appears to slide around glacial form – mechanical	1
D2	ANIMATION	PENGUIN HALF-PIPE – penguin figure slides on ice chunk, as if riding up and down skate half-pipe – mechanical	1
D2	ANIMATION	TEETERING PENGUIN STACK – 4 acrobatic penguin figures stacked on top of one another, “toppling” animation – mechanical	1
D2	ANIMATION	PENGUIN SWINGER 1 – penguin figure swings from ice bridge – mechanical	1
D2	ANIMATION	PENGUIN SWINGER 2 – penguin figure swings from ice bridge – mechanical	1
D2-A	EFFECT	SNOW – Soap-type snow blows from tall glacial towers out both sides over audience	1

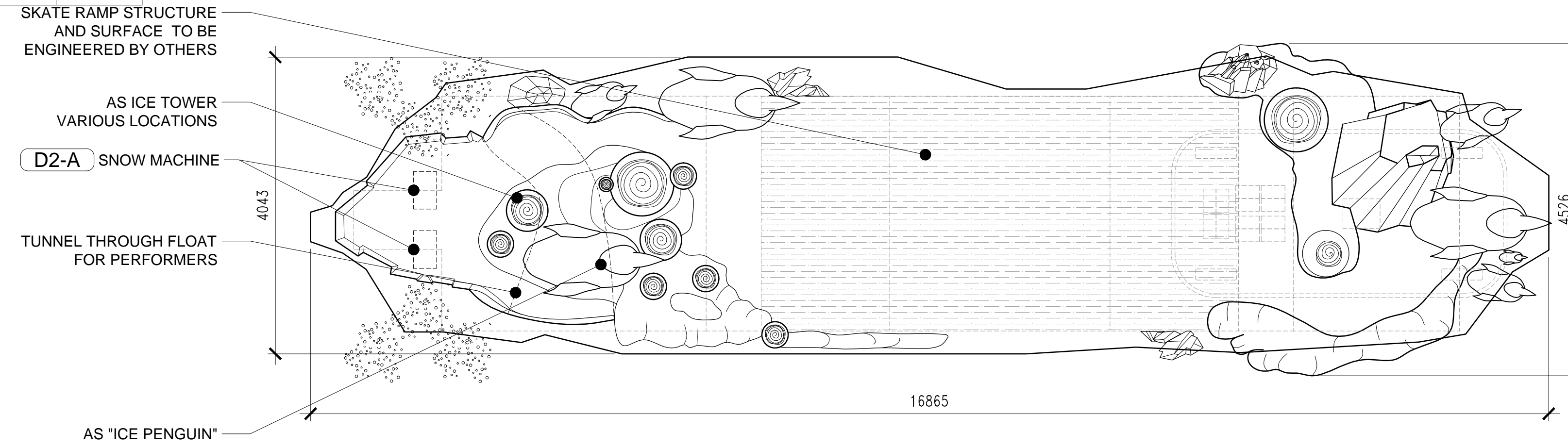

2 CHIMELONG PARADE POLAR GAMES PLAN
1:50

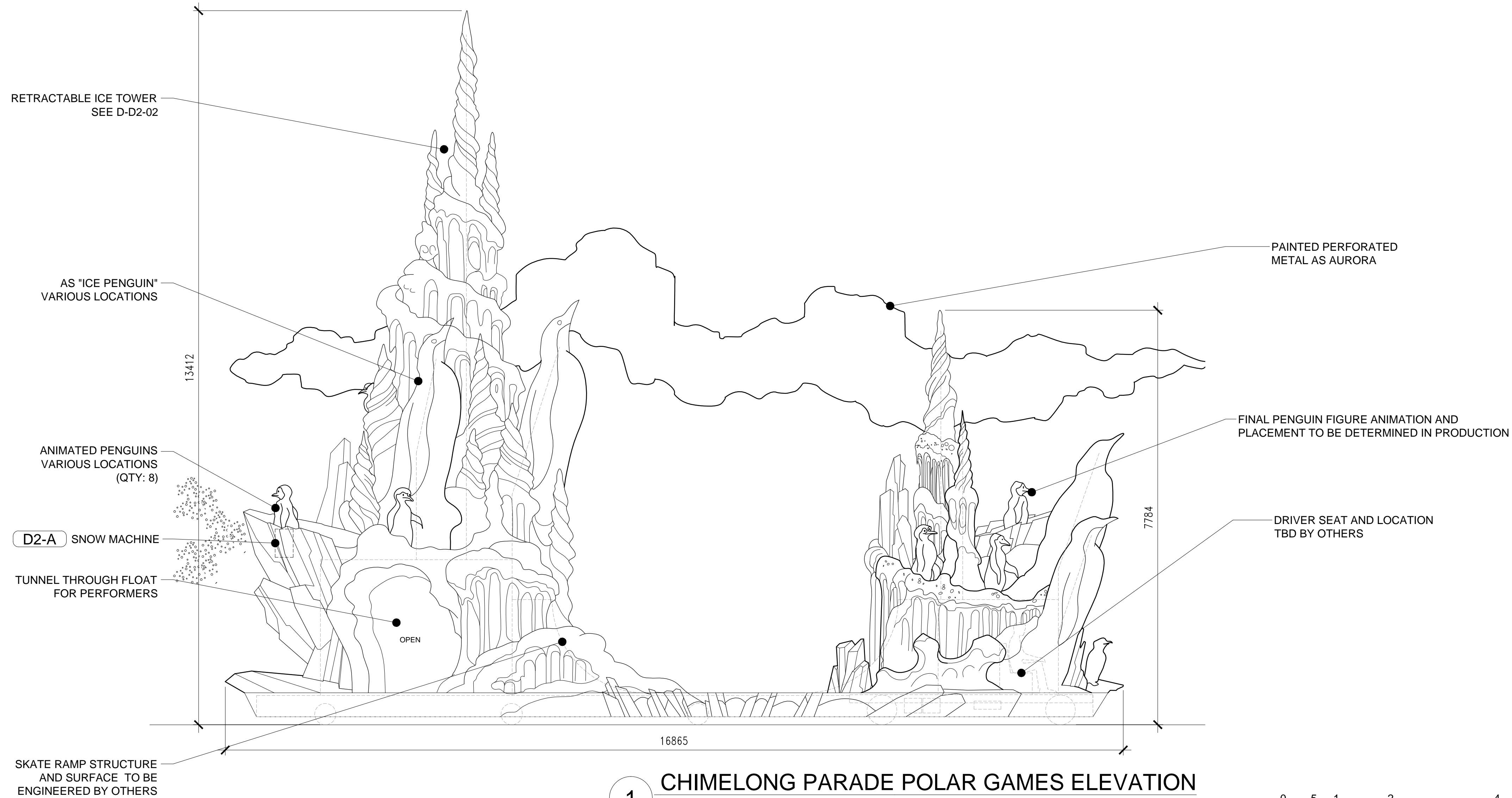

1 CHIMELONG PARADE POLAR GAMES ELEVATION
1:50

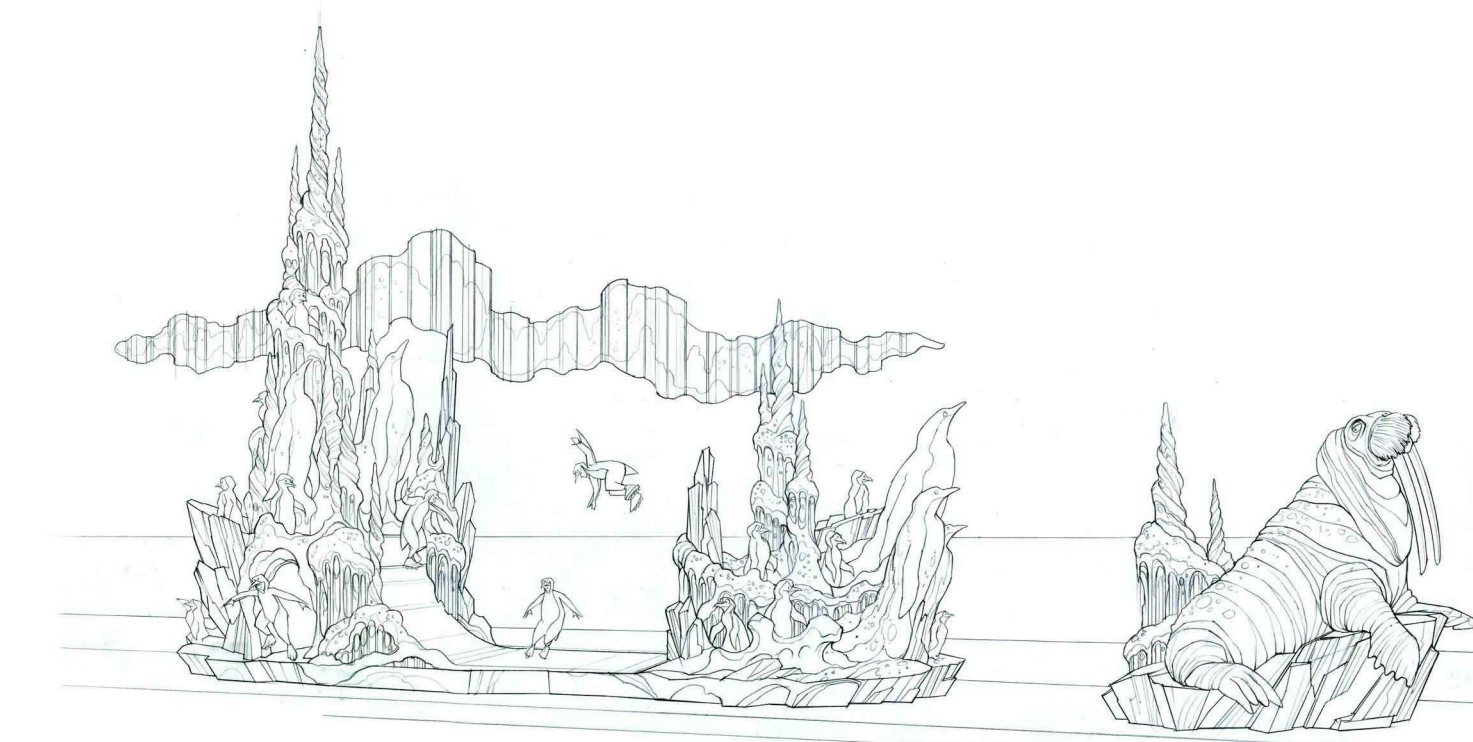

CONCEPT ARTWORK

PROJECT:

HENQIN OCEAN KINGDOM

CLIENT:

Zhuhai Chimelong Investment and Development Co., Ltd.
Chimelong Office G1,
Fuxiang Bay, Hengqin New District
Zhuhai 519031, People's Republic of China

CONSULTANT:

NOTICES:
THESE PARADE DESIGN DOCUMENTS ARE FOR DESIGN INTENT PURPOSE ONLY AND NOT FOR CONSTRUCTION.

ANY PROJECT ARCHITECTURAL DESIGN, ENGINEERING, CONSTRUCTION, COMMISSIONING, AND COMPLIANCE WITH LOCAL LIFE SAFETY AND BUILDING CODES SHALL BE PROVIDED AND PERFORMED BY LOCALLY LICENSED PROFESSIONALS.

THE DATA IN THIS DOCUMENT INCORPORATE PROPRIETARY RIGHTS OF THE HETEMA GROUP, 67 VALLEY STREET PASADENA, CA 91105. ANY PARTY ACCEPTING THIS DOCUMENT DOES SO IN CONFIDENCE AND AGREES THAT IT SHALL NOT BE DUPLICATED, IN WHOLE OR IN PART, OR BE DISCLOSED TO OTHERS, WITHOUT THE PRIOR WRITTEN CONSENT OF THE HETEMA GROUP, INC.

AND
ZHUHAI CHIMELONG INVESTMENT AND DEVELOPMENT CO., LTD.
CHIMELONG OFFICE G1,
FUXIANG BAY, HENQIN NEW DISTRICT
ZHUHAI 519031, PEOPLE'S REPUBLIC OF CHINA

**FINAL DESIGN
PACKAGE UPDATE
PROGRESS PLOT**

ISSUE DATE	DESCRIPTION
2012/09/10	CONCEPT DESIGN
11-OCT-2012	CONCEPT DEVELOPMENT
-	-
-	-
-	-

DRAWING TITLE:
**CHIMELONG PARADE
CONCEPT DEVELOPMENT
POLAR GAMES**

SHEET NO.

D-D2-01

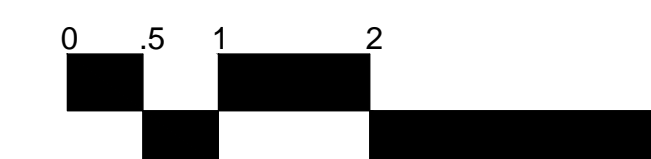

**NOT FOR
CONSTRUCTION**

PROJECT:

HENQIN OCEAN KINGDOM

CLIENT:

Zhuhai Chimelong Investment and Development Co., Ltd.
 Chimelong Office G1,
 Fuxiang Bay, Hengqin New District
 Zhuhai 519031, People's Republic of China

CONSULTANT:

NOTICES:
 THESE PARADE DESIGN DOCUMENTS ARE FOR DESIGN INTENT PURPOSE ONLY AND NOT FOR CONSTRUCTION.

ANY PROJECT ARCHITECTURAL DESIGN, ENGINEERING, CONSTRUCTION, COMMISSIONING, AND COMPLIANCE WITH LOCAL LIFE SAFETY AND BUILDING CODES SHALL BE PROVIDED AND PERFORMED BY LOCALLY LICENSED PROFESSIONALS.

THE DATA IN THIS DOCUMENT INCORPORATE PROPRIETARY RIGHTS OF THE HETEMA GROUP, 67 VALLEY STREET PASADENA, CA 91105. ANY PARTY ACCEPTING THIS DOCUMENT DOES SO IN CONFIDENCE AND AGREES THAT IT SHALL NOT BE DUPLICATED, IN WHOLE OR IN PART, OR BE DISCLOSED TO OTHERS, WITHOUT THE PRIOR WRITTEN CONSENT OF THE HETEMA GROUP, INC. AND ZHUHAI CHIMELONG INVESTMENT AND DEVELOPMENT CO., LTD. CHIMELONG OFFICE G1, FUXIANG BAY, HENQIN NEW DISTRICT ZHUHAI 519031, PEOPLE'S REPUBLIC OF CHINA

FINAL DESIGN
 PACKAGE UPDATE
 PROGRESS PLOT

ISSUE DATE	DESCRIPTION
2012/09/10	CONCEPT DESIGN
11-OCT-2012	CONCEPT DEVELOPMENT
-	-
-	-
-	-

DRAWING TITLE:
 CHIMELONG PARADE
 CONCEPT DEVELOPMENT
 POLAR GAMES

SHEET NO.

D-D2-02

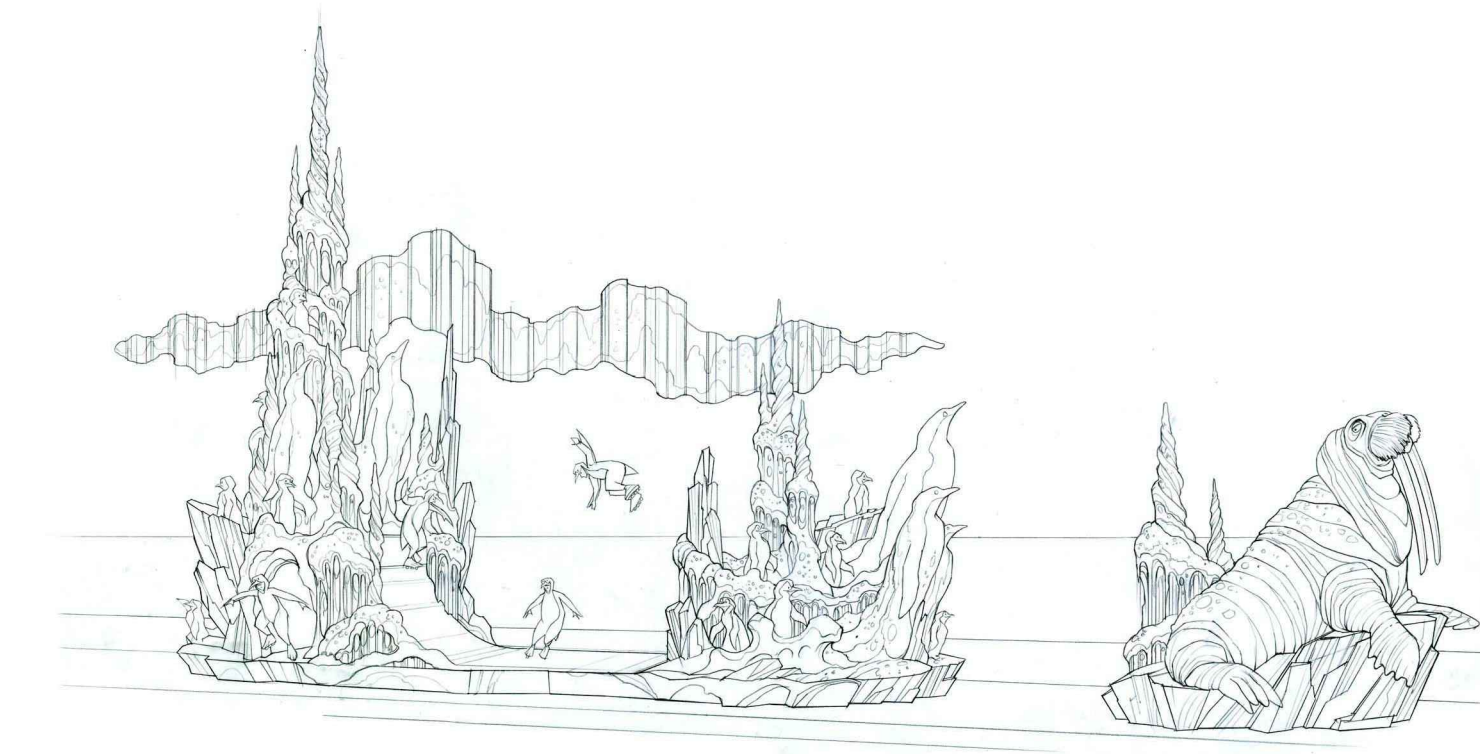

CONCEPT ARTWORK

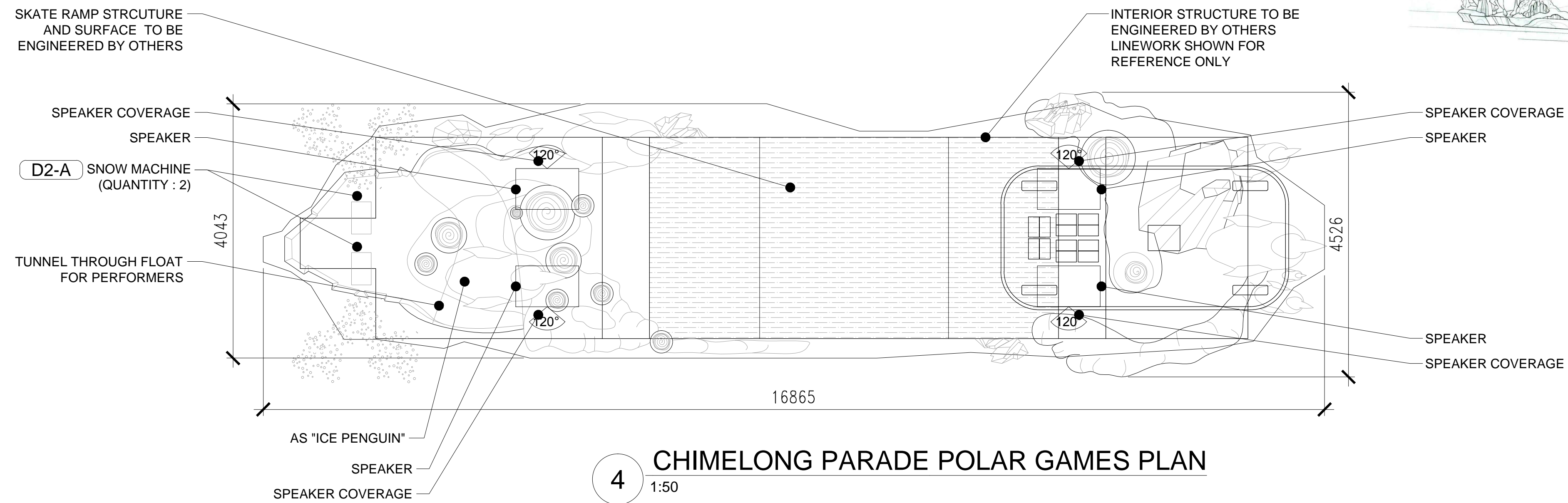

4 CHIMELONG PARADE POLAR GAMES PLAN
 1:50

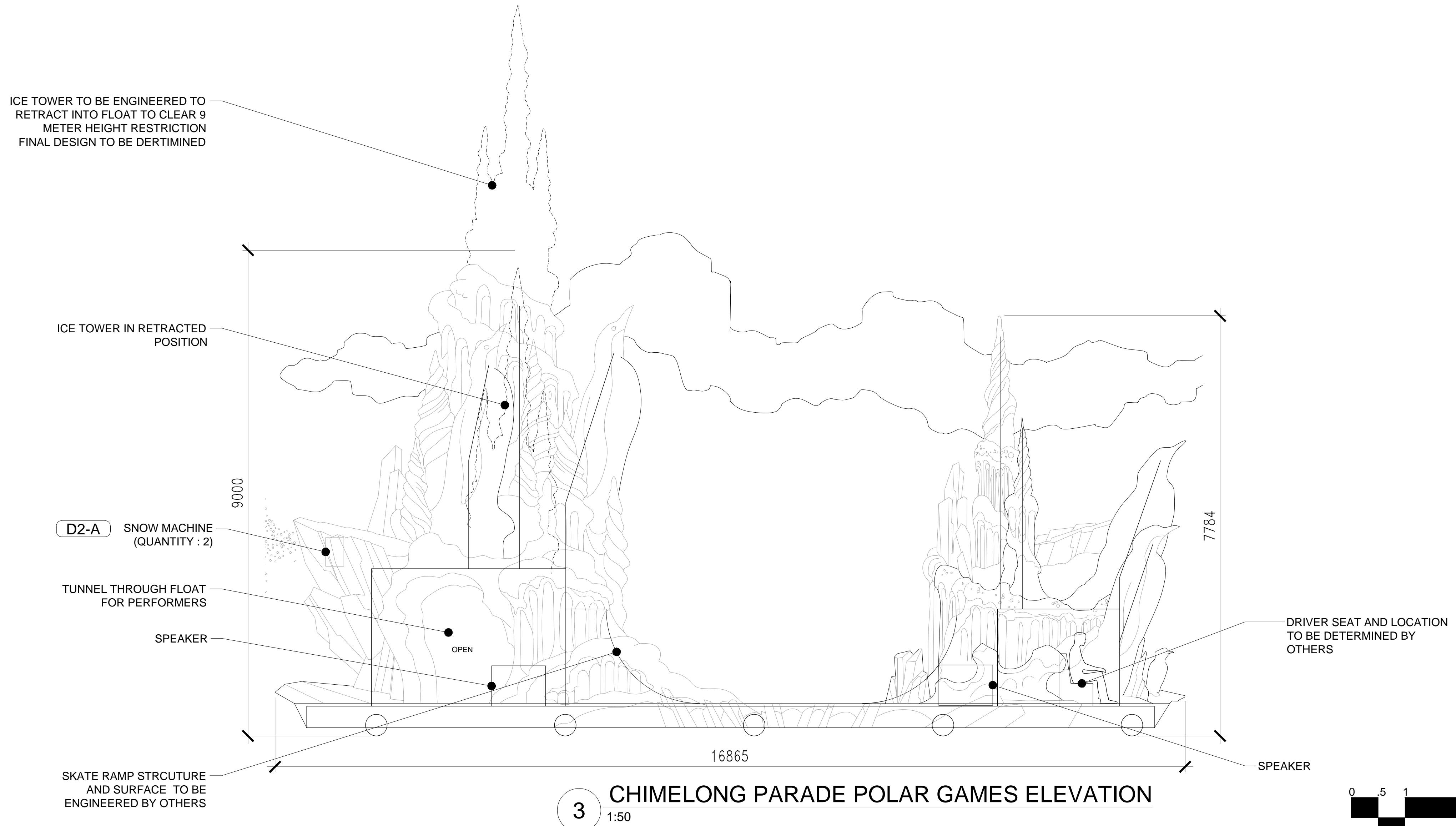

3 CHIMELONG PARADE POLAR GAMES ELEVATION
 1:50

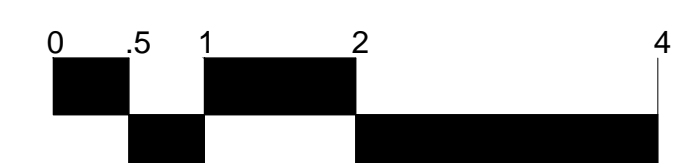

NOT FOR
 CONSTRUCTION

NUMBER	ANIMATION or EFFECT	DESCRIPTION OF ANIMATION OR EFFECT	QUANTITY
E1.1-A	ANIMATION	SNAIL EYES - eye stalks bob and sway reactively - reactive	2
E1.1-B	ANIMATION	SNAIL HEAD NOD - head nods up and down, driven by cam that runs on street - mechanical, cam	1

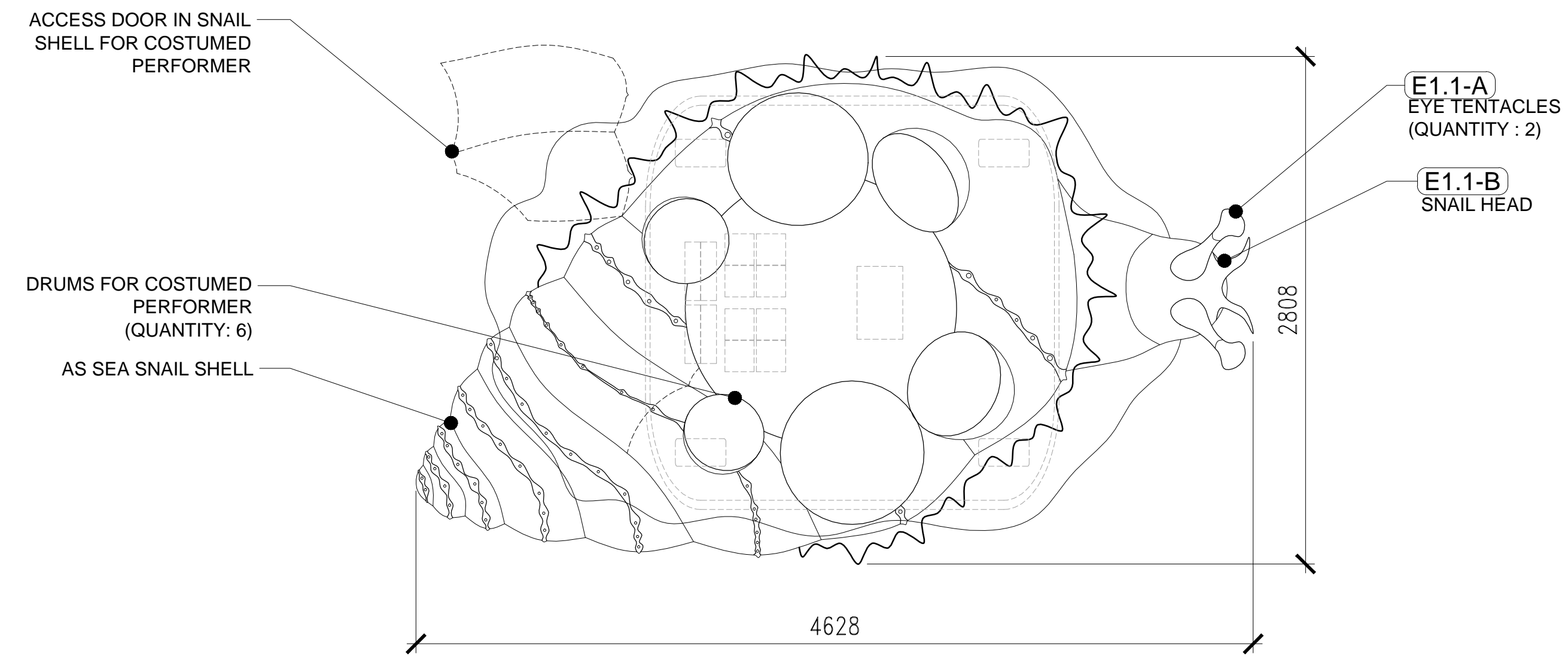

2 CHIMELONG PARADE CRAB CONGA LINE: SEA SNAIL PLAN
1:25

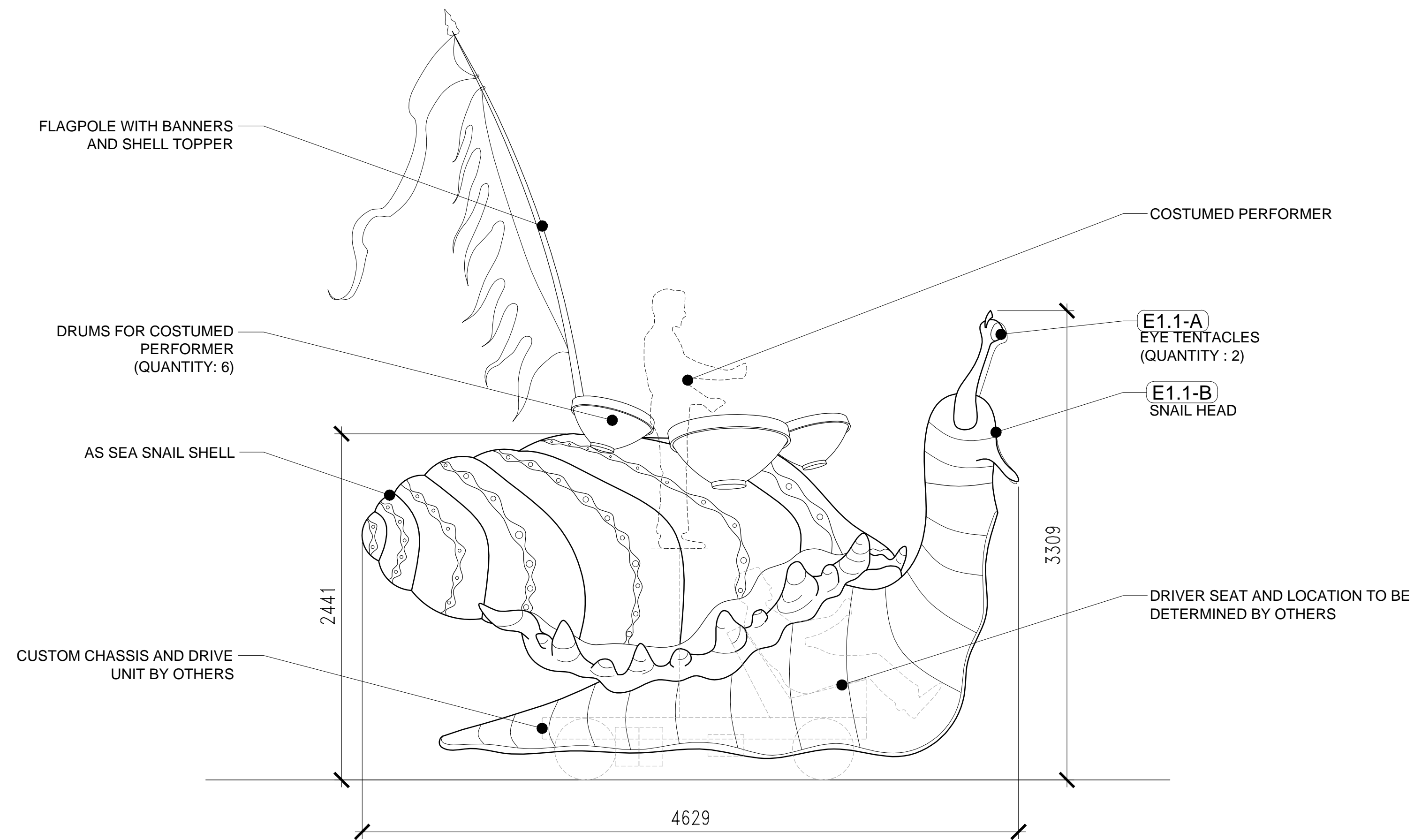

1 CHIMELONG PARADE CRAB CONGA LINE: SEA SNAIL ELEVATION
1:25

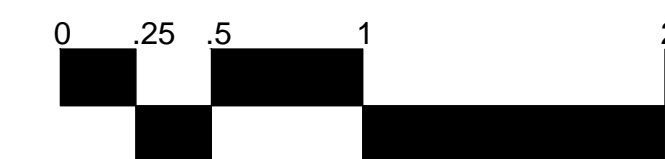

NOT FOR CONSTRUCTION



CONCEPT ARTWORK

PROJECT:

HENQIN OCEAN KINGDOM

CLIENT:

Zhuhai Chimelong Investment and Development Co., Ltd.
Chimelong Office G1,
Fuxiang Bay, Hengqin New District
Zhuhai 519031, People's Republic of China

CONSULTANT:

NOTICES:
THESE PARADE DESIGN DOCUMENTS ARE FOR DESIGN INTENT PURPOSE ONLY AND NOT FOR CONSTRUCTION.

ANY PROJECT ARCHITECTURAL DESIGN, ENGINEERING, CONSTRUCTION, COMMISSIONING, AND COMPLIANCE WITH LOCAL LIFE SAFETY AND BUILDING CODES SHALL BE PROVIDED AND PERFORMED BY LOCALLY LICENSED PROFESSIONALS.

THE DATA IN THIS DOCUMENT INCORPORATE PROPRIETARY RIGHTS OF THE HETEMA GROUP, 67 VALLEY STREET PASADENA, CA 91105. ANY PARTY ACCEPTING THIS DOCUMENT DOES SO IN CONFIDENCE AND AGREES THAT IT SHALL NOT BE DUPLICATED, IN WHOLE OR IN PART, OR BE DISCLOSED TO OTHERS, WITHOUT THE PRIOR WRITTEN CONSENT OF THE HETEMA GROUP, INC. AND ZHUHAI CHIMELONG INVESTMENT AND DEVELOPMENT CO., LTD. CHIMELONG OFFICE G1, FUXIANG BAY, HENQIN NEW DISTRICT ZHUHAI 519031, PEOPLE'S REPUBLIC OF CHINA

FINAL DESIGN PACKAGE UPDATE PROGRESS PLOT

ISSUE DATE	DESCRIPTION
2012/09/10	CONCEPT DESIGN
11-OCT-2012	CONCEPT DEVELOPMENT
-	-
-	-
-	-

DRAWING TITLE:
CHIMELONG PARADE CONCEPT DEVELOPMENT CRAB CONGA LINE: SEA SNAIL

SHEET NO.

D-E1.1-01

PROJECT:

HENQIN OCEAN KINGDOM

CLIENT:

Zhuhai Chimelong Investment and Development Co., Ltd.
 Chimelong Office G1,
 Fuxiang Bay, Hengqin New District
 Zhuhai 519031, People's Republic of China

CONSULTANT:

NOTICES:
 THESE PARADE DESIGN DOCUMENTS ARE FOR DESIGN INTENT PURPOSE ONLY AND NOT FOR CONSTRUCTION.

ANY PROJECT ARCHITECTURAL DESIGN, ENGINEERING, CONSTRUCTION, COMMISSIONING, AND COMPLIANCE WITH LOCAL LIFE SAFETY AND BUILDING CODES SHALL BE PROVIDED AND PERFORMED BY LOCALLY LICENSED PROFESSIONALS.

THE DATA IN THIS DOCUMENT INCORPORATE PROPRIETARY RIGHTS OF THE HETEMA GROUP, 67 VALLEY STREET PASADENA, CA 91105. ANY PARTY ACCEPTING THIS DOCUMENT DOES SO IN CONFIDENCE AND AGREES THAT IT SHALL NOT BE DUPLICATED, IN WHOLE OR IN PART, OR BE DISCLOSED TO OTHERS, WITHOUT THE PRIOR WRITTEN CONSENT OF THE HETEMA GROUP, INC. AND ZHUHAI CHIMELONG INVESTMENT AND DEVELOPMENT CO., LTD. CHIMELONG OFFICE G1, FUXIANG BAY, HENQIN NEW DISTRICT ZHUHAI 519031, PEOPLE'S REPUBLIC OF CHINA

FINAL DESIGN
 PACKAGE UPDATE
 PROGRESS PLOT

ISSUE DATE	DESCRIPTION
2012/09/10	CONCEPT DESIGN
11-OCT-2012	CONCEPT DEVELOPMENT
-	-
-	-
-	-

DRAWING TITLE:
 CHIMELONG PARADE
 CONCEPT DEVELOPMENT
 CRAB CONGA LINE:
 SEA SNAIL

SHEET NO.

D-E1.1-02



CONCEPT ARTWORK

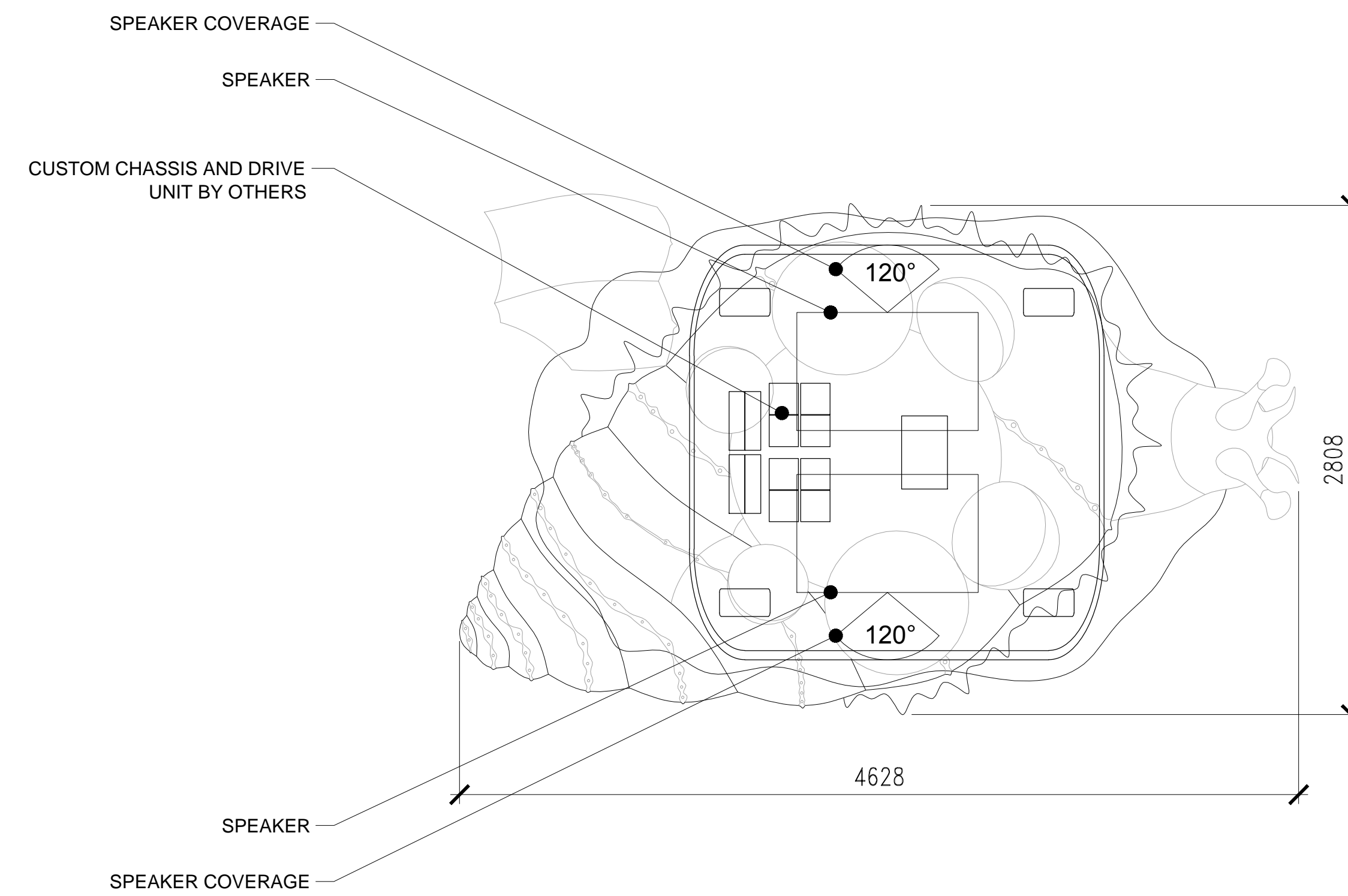

4 CHIMELONG PARADE CRAB CONGA LINE: SEA SNAIL PLAN
 1:25

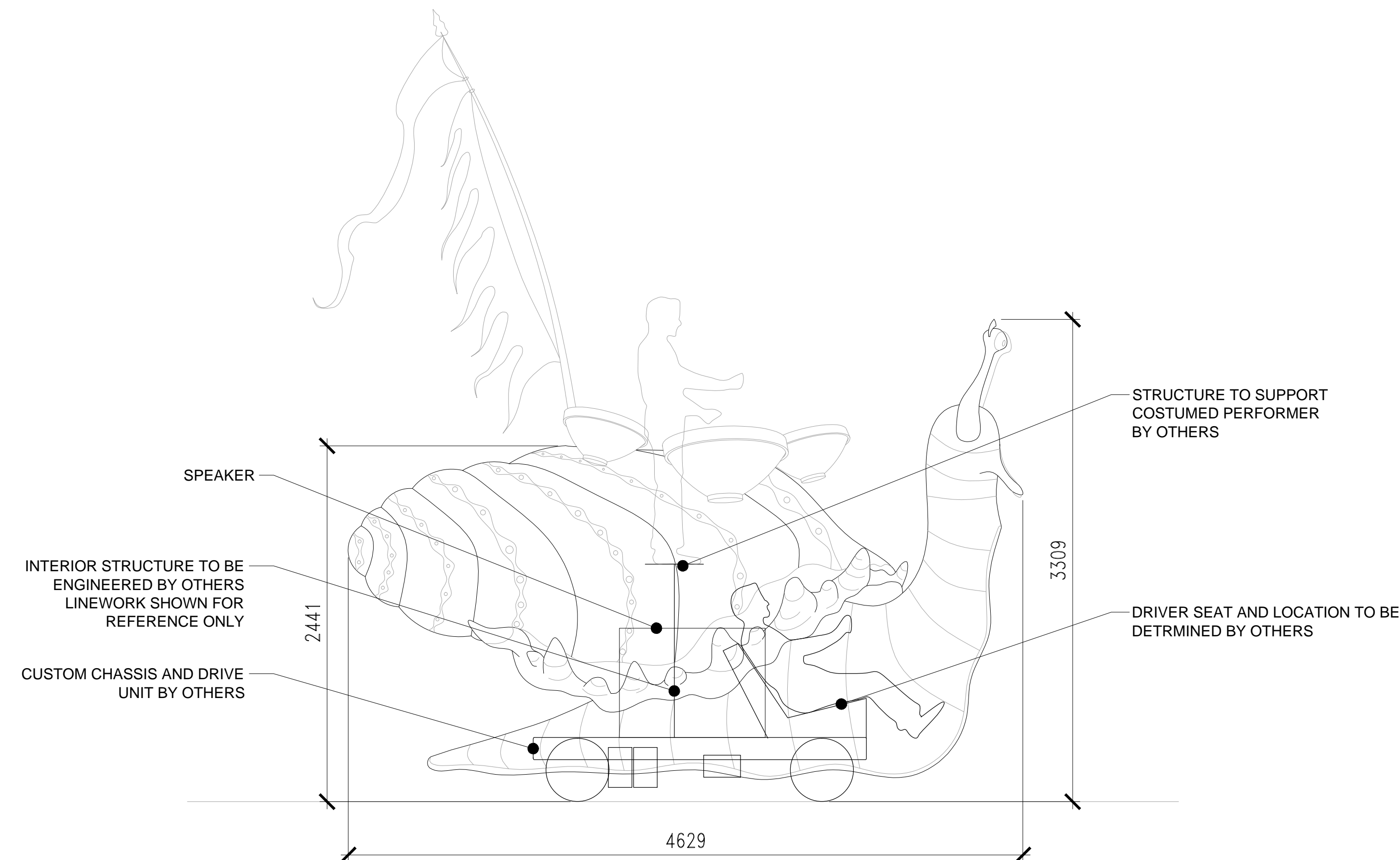

3 CHIMELONG PARADE CRAB CONGA LINE: SEA SNAIL ELEVATION
 1:25

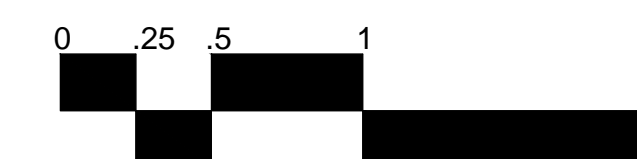

NOT FOR
 CONSTRUCTION

NUMBER	ANIMATION or EFFECT	DESCRIPTION OF ANIMATION OR EFFECT	QUANTITY
E1.2-A	ANIMATION	CRAB EYES - sway animation - reactive	2
E1.2-B	ANIMATION	CRAB BODY ROCKING/ LEG FLEX - body pivot left/ right, legs reactive - puppet	1
E1.2-C	ANIMATION	CRAB CLAWS/ARMS - extremely flexible claws/arms - puppet	2
E1.2-D	ANIMATION	CRAB LEGS - left/right up/down animation - puppet	2

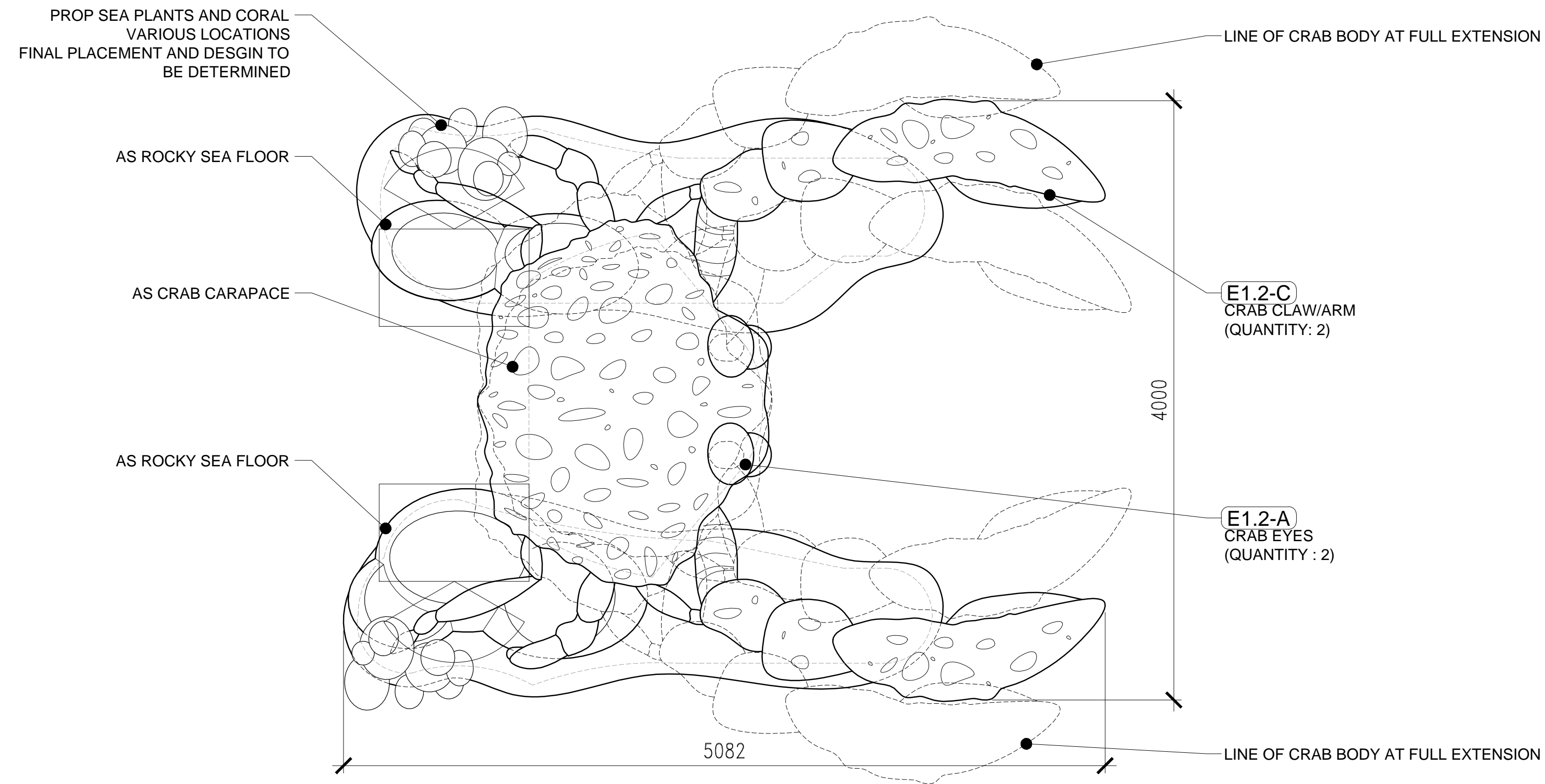

2 CHIMELONG PARADE CRAB CONGA LINE: CRAB PLAN
1:25

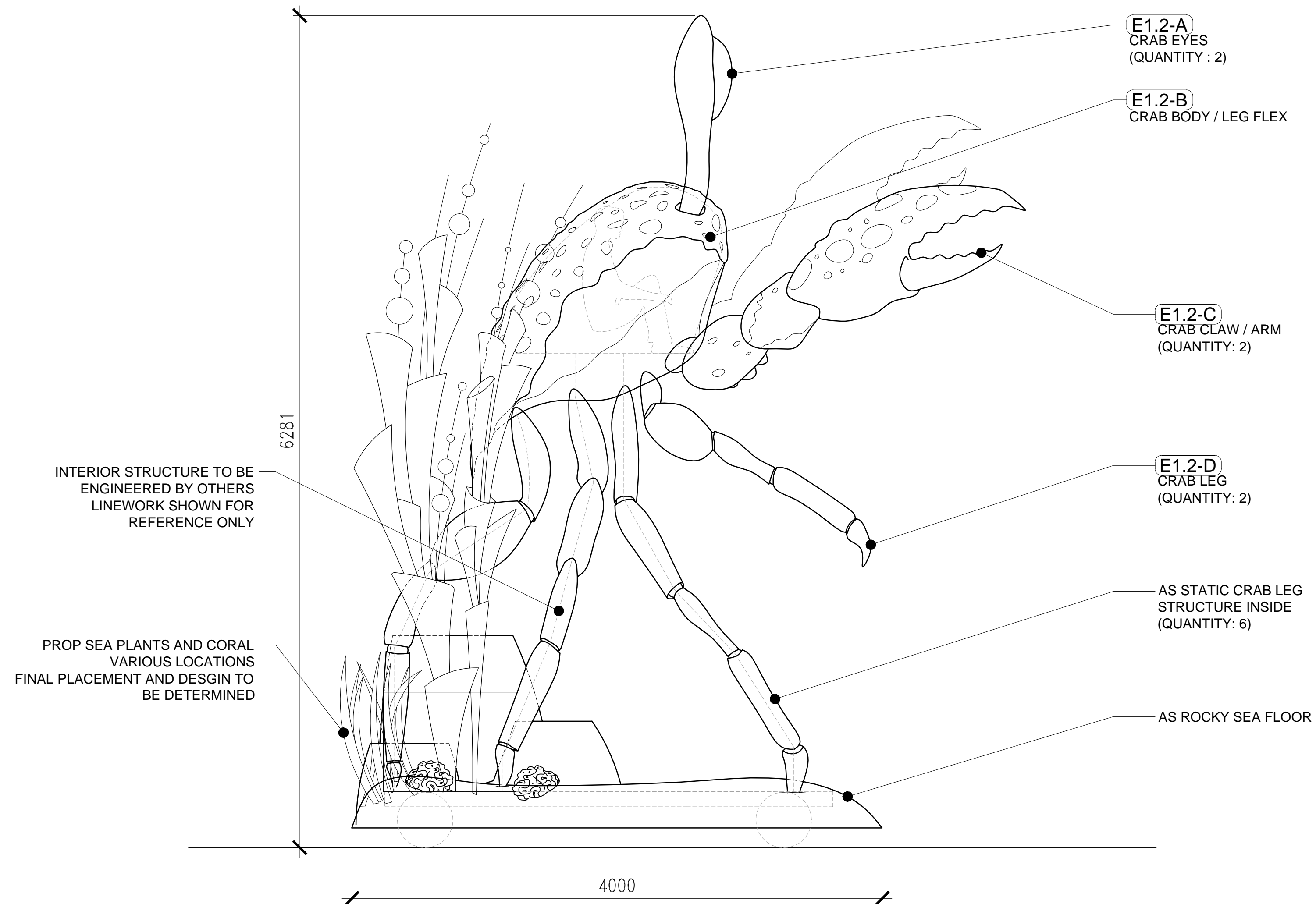

1 CHIMELONG PARADE CRAB CONGA LINE: CRAB PLAN
1:25

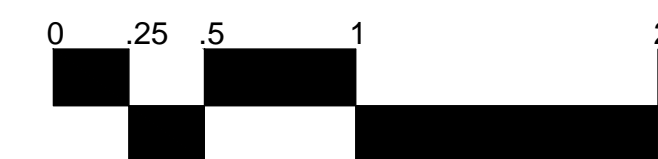

NOT FOR CONSTRUCTION

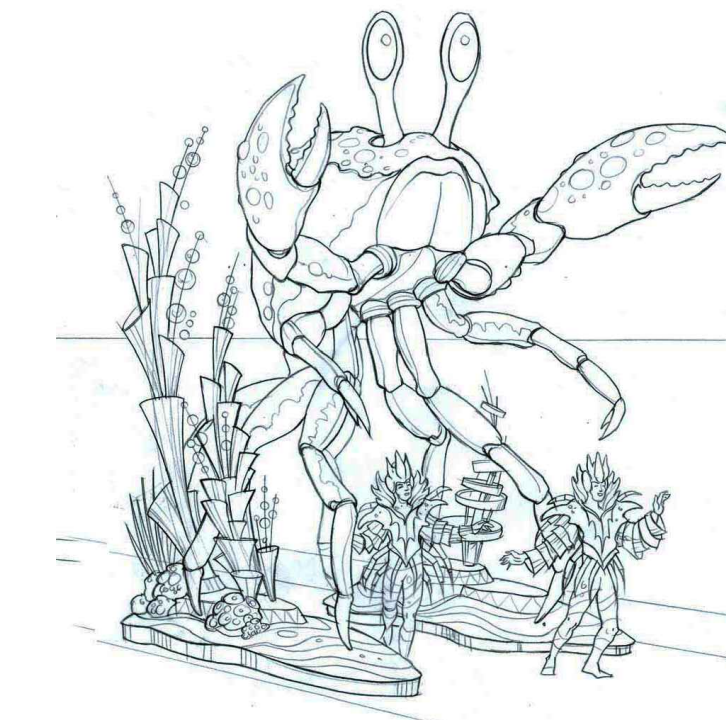

CONCEPT ARTWORK

ISSUE DATE	DESCRIPTION
2012/09/10	CONCEPT DESIGN
11-OCT-2012	CONCEPT DEVELOPMENT
-	-
-	-
-	-

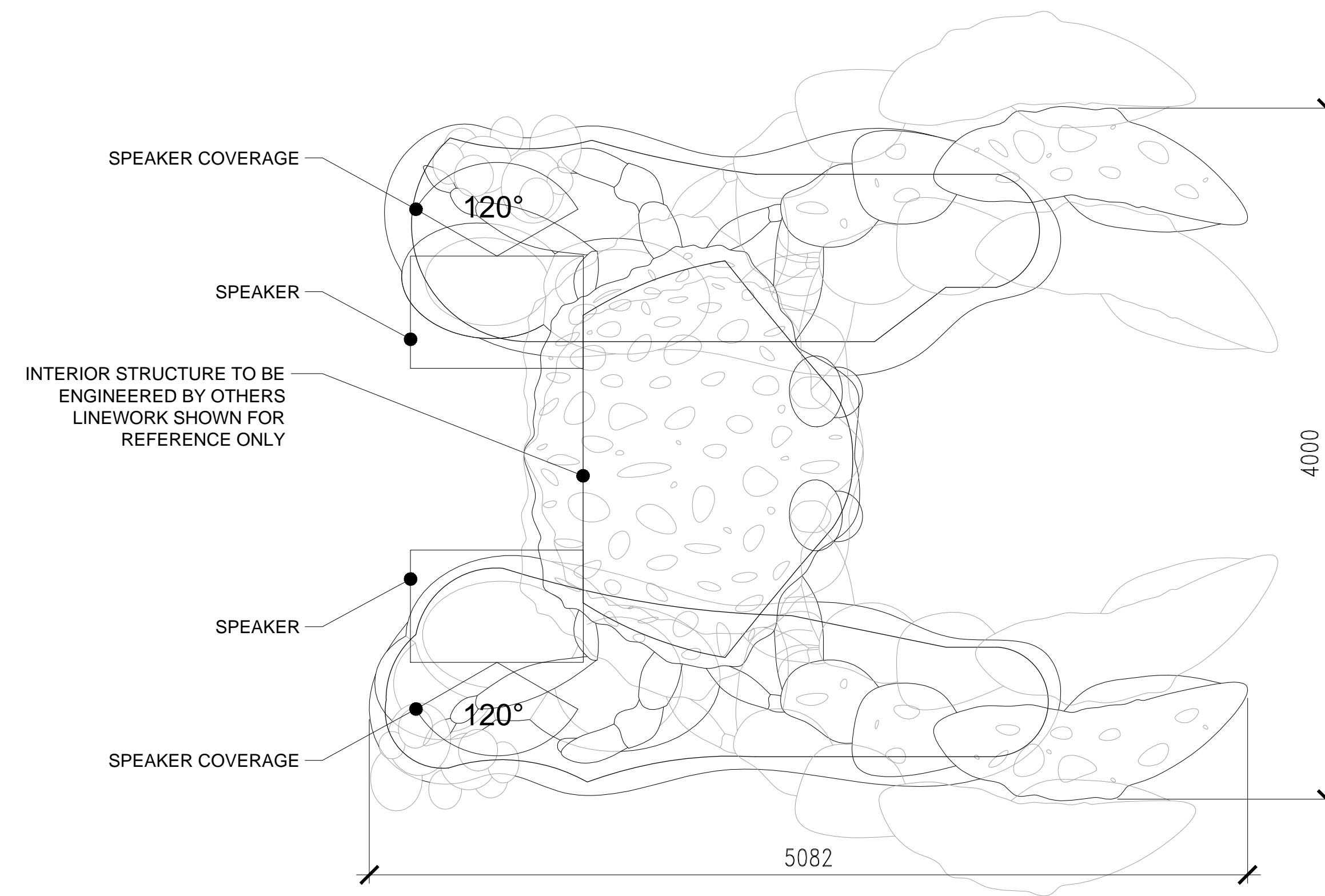

4 CHIMELONG PARADE CRAB CONGA LINE: CRAB PLAN
1:25

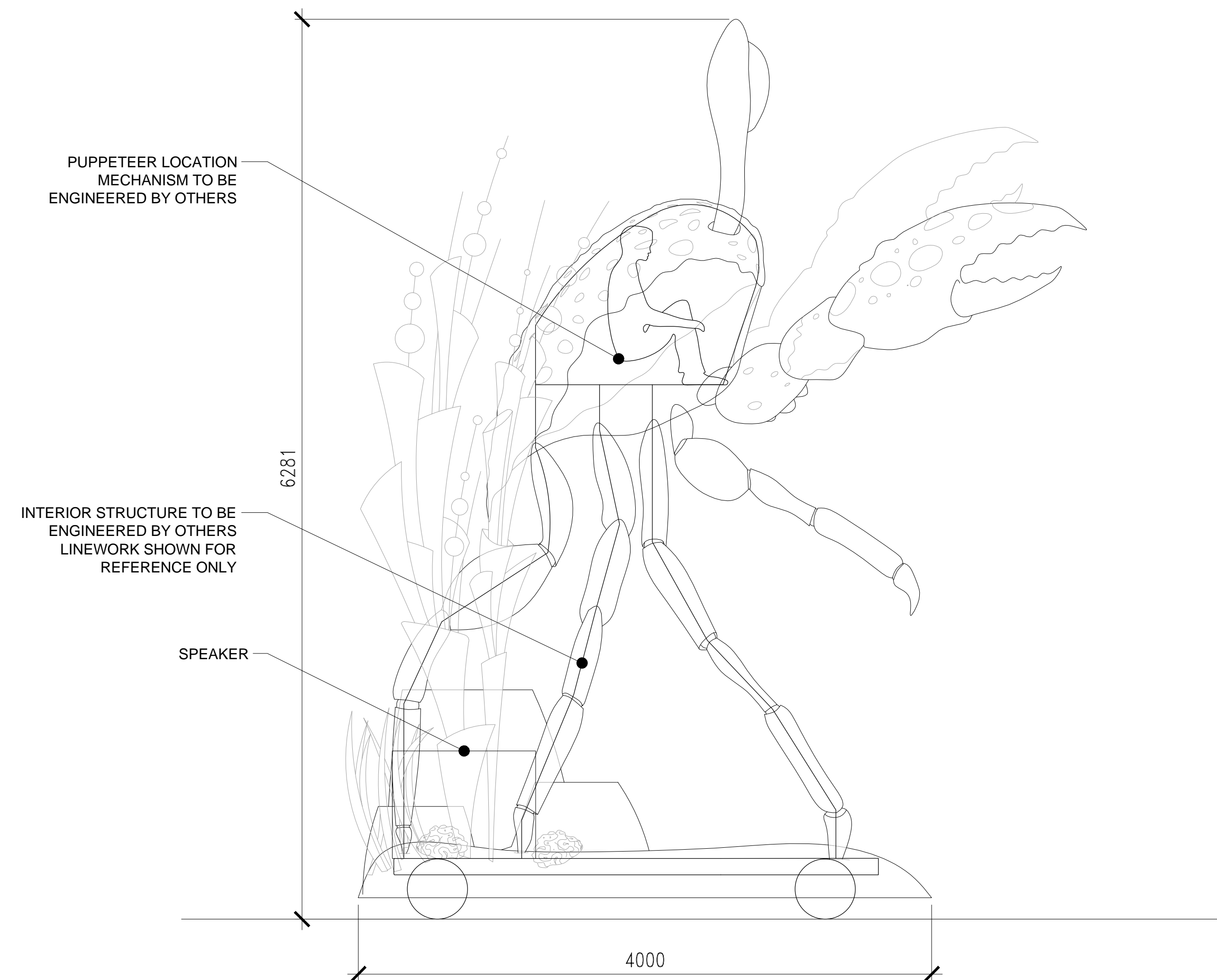

3 CHIMELONG PARADE CRAB CONGA LINE: CRAB PLAN
1:25

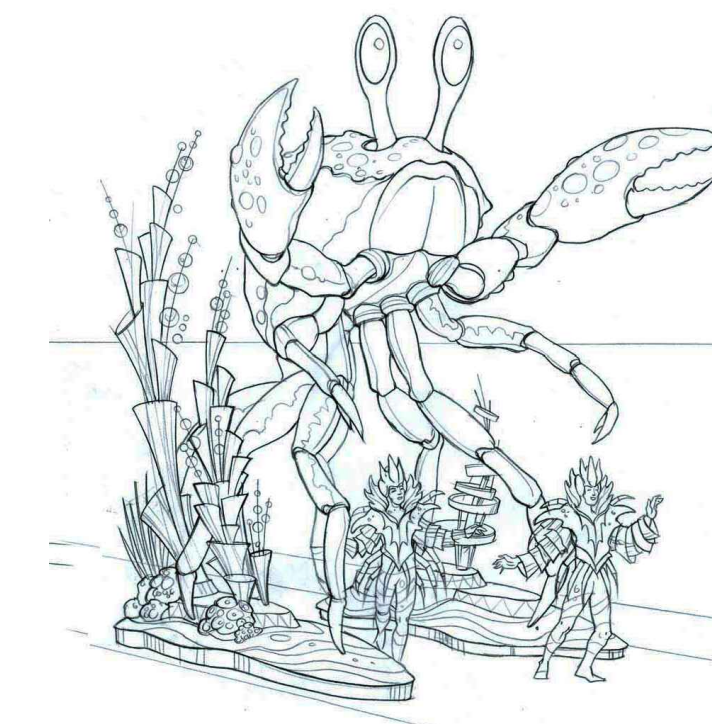

CONCEPT ARTWORK

PROJECT:

HENQIN OCEAN KINGDOM

CLIENT:

Zhuhai Chimelong Investment and Development Co., Ltd.
Chimelong Office G1,
Fuxiang Bay, Hengqin New District
Zhuhai 519031, People's Republic of China

CONSULTANT:

NOTICES:
THESE PARADE DESIGN DOCUMENTS ARE FOR DESIGN INTENT PURPOSE ONLY AND NOT FOR CONSTRUCTION.

ANY PROJECT ARCHITECTURAL DESIGN, ENGINEERING, CONSTRUCTION, COMMISSIONING, AND COMPLIANCE WITH LOCAL LIFE SAFETY AND BUILDING CODES SHALL BE PROVIDED AND PERFORMED BY LOCALLY LICENSED PROFESSIONALS.

THE DATA IN THIS DOCUMENT INCORPORATE PROPRIETARY RIGHTS OF THE HETEMA GROUP, 67 VALLEY STREET PASADENA, CA 91105. ANY PARTY ACCEPTING THIS DOCUMENT DOES SO IN CONFIDENCE AND AGREES THAT IT SHALL NOT BE DUPLICATED, IN WHOLE OR IN PART, OR BE DISCLOSED TO OTHERS, WITHOUT THE PRIOR WRITTEN CONSENT OF THE HETEMA GROUP, INC. AND ZHUHAI CHIMELONG INVESTMENT AND DEVELOPMENT CO., LTD. CHIMELONG OFFICE G1, FUXIANG BAY, HENQIN NEW DISTRICT ZHUHAI 519031, PEOPLE'S REPUBLIC OF CHINA

FINAL DESIGN
PACKAGE UPDATE
PROGRESS PLOT

ISSUE DATE	DESCRIPTION
2012/09/10	CONCEPT DESIGN
11-OCT-2012	CONCEPT DEVELOPMENT
-	-
-	-
-	-

DRAWING TITLE:
CHIMELONG PARADE
CONCEPT DEVELOPMENT
CRAB CONGA LINE:
CRAB

SHEET NO.

D-E1.2-02

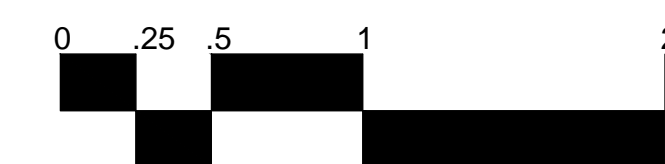

NOT FOR
CONSTRUCTION

NUMBER	ANIMATION or EFFECT	DESCRIPTION OF ANIMATION OR EFFECT	QUANTITY
E2-A	ANIMATION	LOBSTER BODY - body left/ right, up/down - puppet	1
E2-B	ANIMATION	LOBSTER ARMS/ CLAWS - extremely dynamic arms/ claws - puppet	2
E2-C	ANIMATION	CRAB DRUMMERS - drumming animation - mechanical	4

INTERIOR STRUCTURE TO BE ENGINEERED BY OTHERS LINEWORK SHOWN FOR REFERENCE ONLY

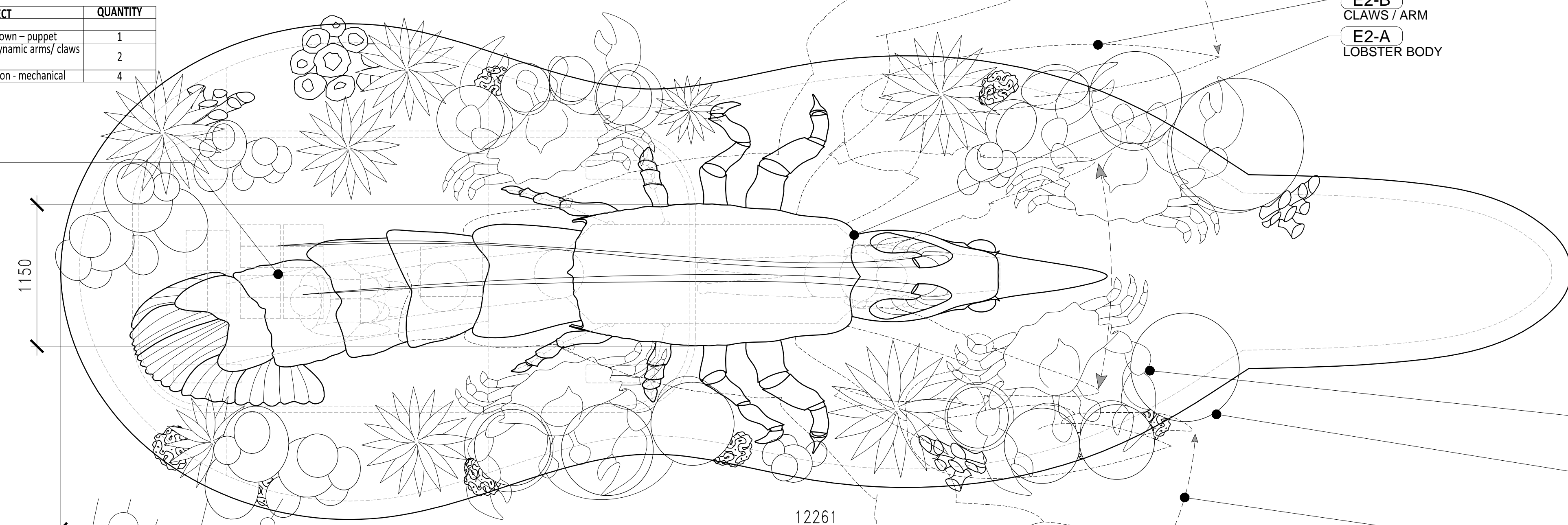

CONCEPT ARTWORK

E2-C CRAB "DRUMMER" (QUANTITY: 4)

PROP DRUMS (QUANTITY: 15)

LOBSTER CLAW AND BODY MOTION

2 CHIMELONG PARADE CRUSTACEAN CARNIVAL PLAN
1:25

8564

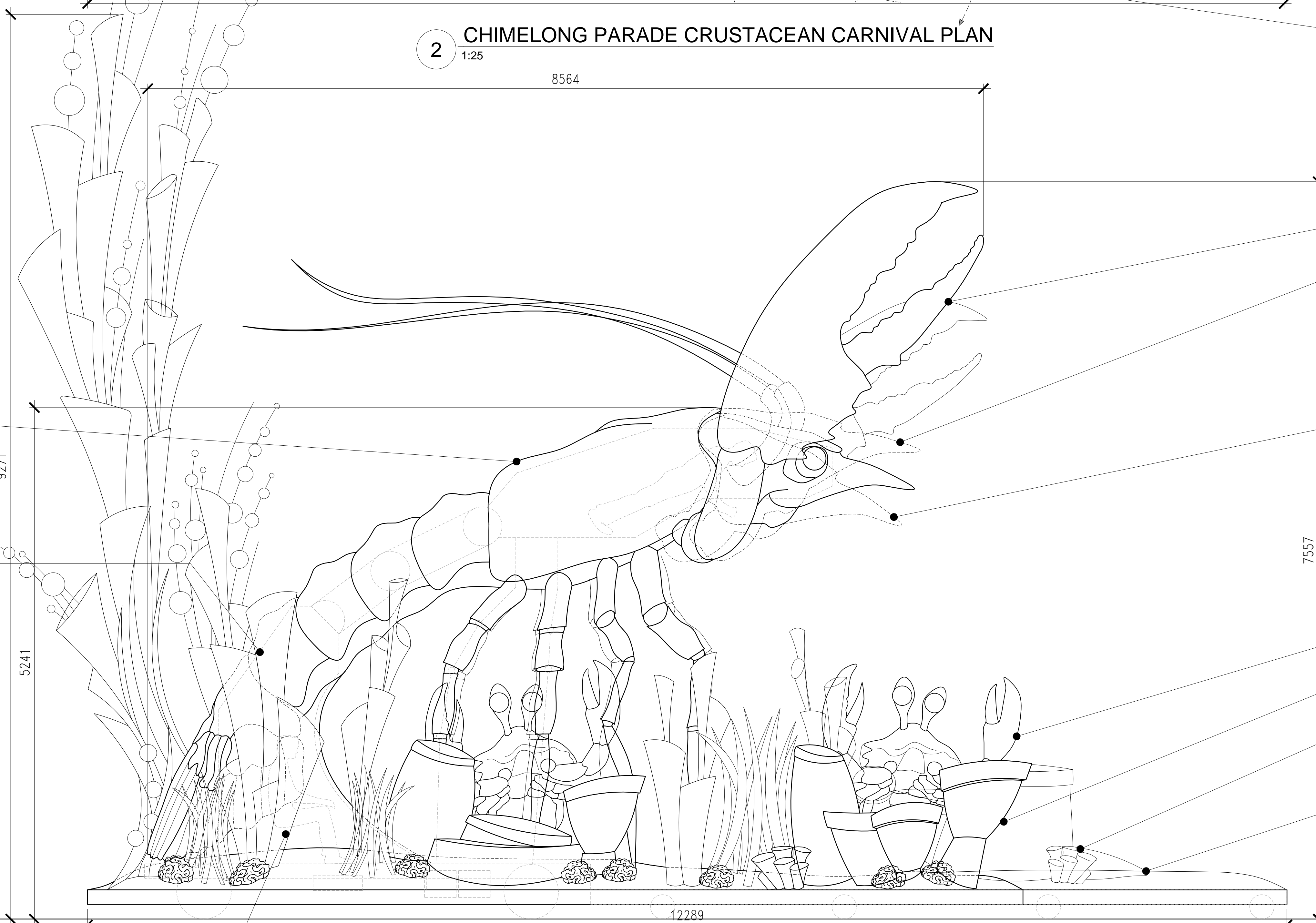

1 CHIMELONG PARADE CRUSTACEAN CARNIVAL ELEVATION
1:25

DRIVER SEAT AND LOCATION TO BE DETERMINED BY OTHERS

E2-B CLAWS / ARM

LINE OF HEAD AT FULL EXTENSION

LINE OF HEAD AT FULL EXTENSION

E2-C CRAB "DRUMMER" (QUANTITY: 4)

PROP DRUMS (QUANTITY: 15)

PROP SEA PLANTS AND CORAL VARIOUS LOCATIONS FINAL DESIGN AND LOCATIONS TO BE DETERMINED

AS SANDY SEA FLOOR

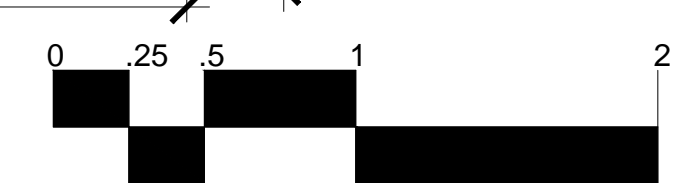

NOT FOR CONSTRUCTION



PROJECT:
HENQIN OCEAN KINGDOM

CLIENT:
Zhuhai Chimelong Investment and Development Co., Ltd.
Chimelong Office G1,
Fuxiang Bay, Hengqin New District
Zhuhai 519031, People's Republic of China

CONSULTANT:

NOTICES:
THESE PARADE DESIGN DOCUMENTS ARE FOR DESIGN INTENT PURPOSE ONLY AND NOT FOR CONSTRUCTION.
ANY PROJECT ARCHITECTURAL DESIGN, ENGINEERING, CONSTRUCTION, COMMISSIONING, AND COMPLIANCE WITH LOCAL LIFE SAFETY AND BUILDING CODES SHALL BE PROVIDED AND PERFORMED BY LOCALLY LICENSED PROFESSIONALS.
THE DATA IN THIS DOCUMENT INCORPORATE PROPRIETARY RIGHTS OF THE HETEMA GROUP, 67 VALLEY STREET PASADENA, CA 91105. ANY PARTY ACCEPTING THIS DOCUMENT DOES SO IN CONFIDENCE AND AGREES THAT IT SHALL NOT BE DUPLICATED, IN WHOLE OR IN PART, OR BE DISCLOSED TO OTHERS, WITHOUT THE PRIOR WRITTEN CONSENT OF THE HETEMA GROUP, INC. AND ZHUHAI CHIMELONG INVESTMENT AND DEVELOPMENT CO., LTD. CHIMELONG OFFICE G1, FUXIANG BAY, HENQIN NEW DISTRICT ZHUHAI 519031, PEOPLE'S REPUBLIC OF CHINA

FINAL DESIGN PACKAGE UPDATE PROGRESS PLOT

ISSUE DATE	DESCRIPTION
2012/09/10	CONCEPT DESIGN
11-OCT-2012	CONCEPT DEVELOPMENT

DRAWING TITLE:
CHIMELONG PARADE CONCEPT DEVELOPMENT CRUSTACEAN CARNIVAL

SHEET NO.
D-E2-01

PROJECT:

HENQIN OCEAN KINGDOM

CLIENT:

Zhuhai Chimelong Investment and Development Co., Ltd.
 Chimelong Office G1,
 Fuxiang Bay, Hengqin New District
 Zhuhai 519031, People's Republic of China

CONSULTANT:

NOTICES:
 THESE PARADE DESIGN DOCUMENTS ARE FOR DESIGN INTENT PURPOSE ONLY AND NOT FOR CONSTRUCTION.

ANY PROJECT ARCHITECTURAL DESIGN, ENGINEERING, CONSTRUCTION, COMMISSIONING, AND COMPLIANCE WITH LOCAL LIFE SAFETY AND BUILDING CODES SHALL BE PROVIDED AND PERFORMED BY LOCALLY LICENSED PROFESSIONALS.

THE DATA IN THIS DOCUMENT INCORPORATE PROPRIETARY RIGHTS OF THE HETEMA GROUP, 67 VALLEY STREET PASADENA, CA 91105. ANY PARTY ACCEPTING THIS DOCUMENT DOES SO IN CONFIDENCE AND AGREES THAT IT SHALL NOT BE DUPLICATED, IN WHOLE OR IN PART, OR BE DISCLOSED TO OTHERS, WITHOUT THE PRIOR WRITTEN CONSENT OF THE HETEMA GROUP, INC. AND ZHUHAI CHIMELONG INVESTMENT AND DEVELOPMENT CO., LTD. CHIMELONG OFFICE G1, FUXIANG BAY, HENQIN NEW DISTRICT ZHUHAI 519031, PEOPLE'S REPUBLIC OF CHINA

FINAL DESIGN
 PACKAGE UPDATE
 PROGRESS PLOT

ISSUE DATE	DESCRIPTION
2012/09/10	CONCEPT DESIGN
11-OCT-2012	CONCEPT DEVELOPMENT
-	-
-	-
-	-

DRAWING TITLE:
 CHIMELONG PARADE
 CONCEPT DEVELOPMENT
 CRUSTACEAN CARNIVAL

SHEET NO.

D-E2-02



CONCEPT ARTWORK

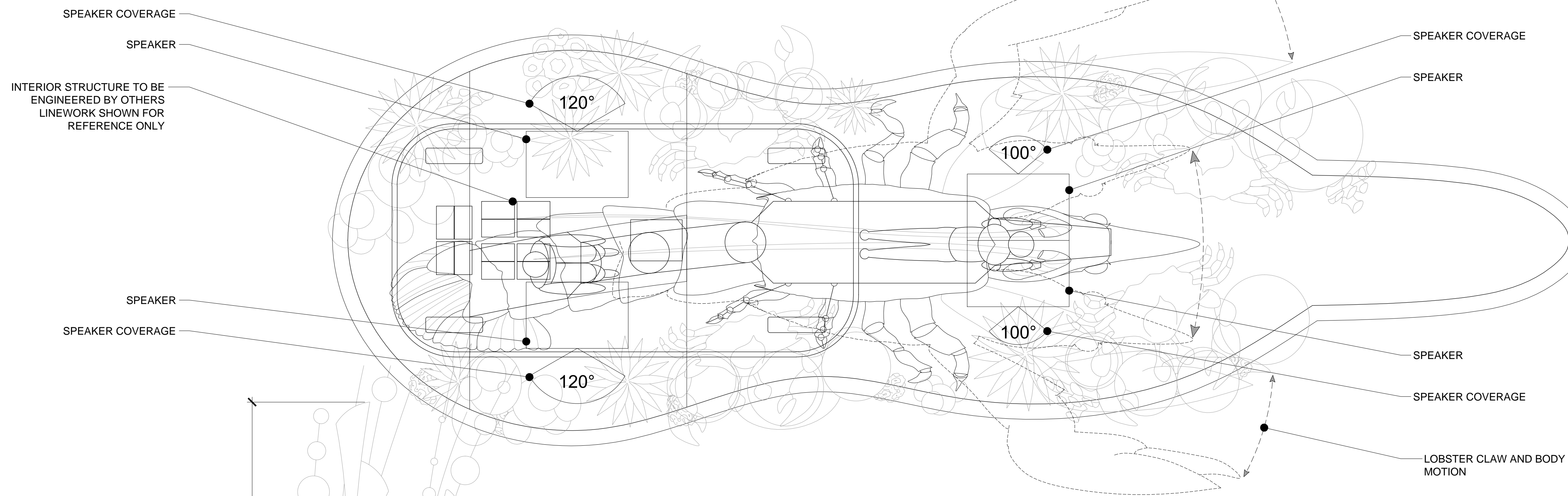

4 CHIMELONG PARADE CRUSTACEAN CARNIVAL PLAN
 1:50

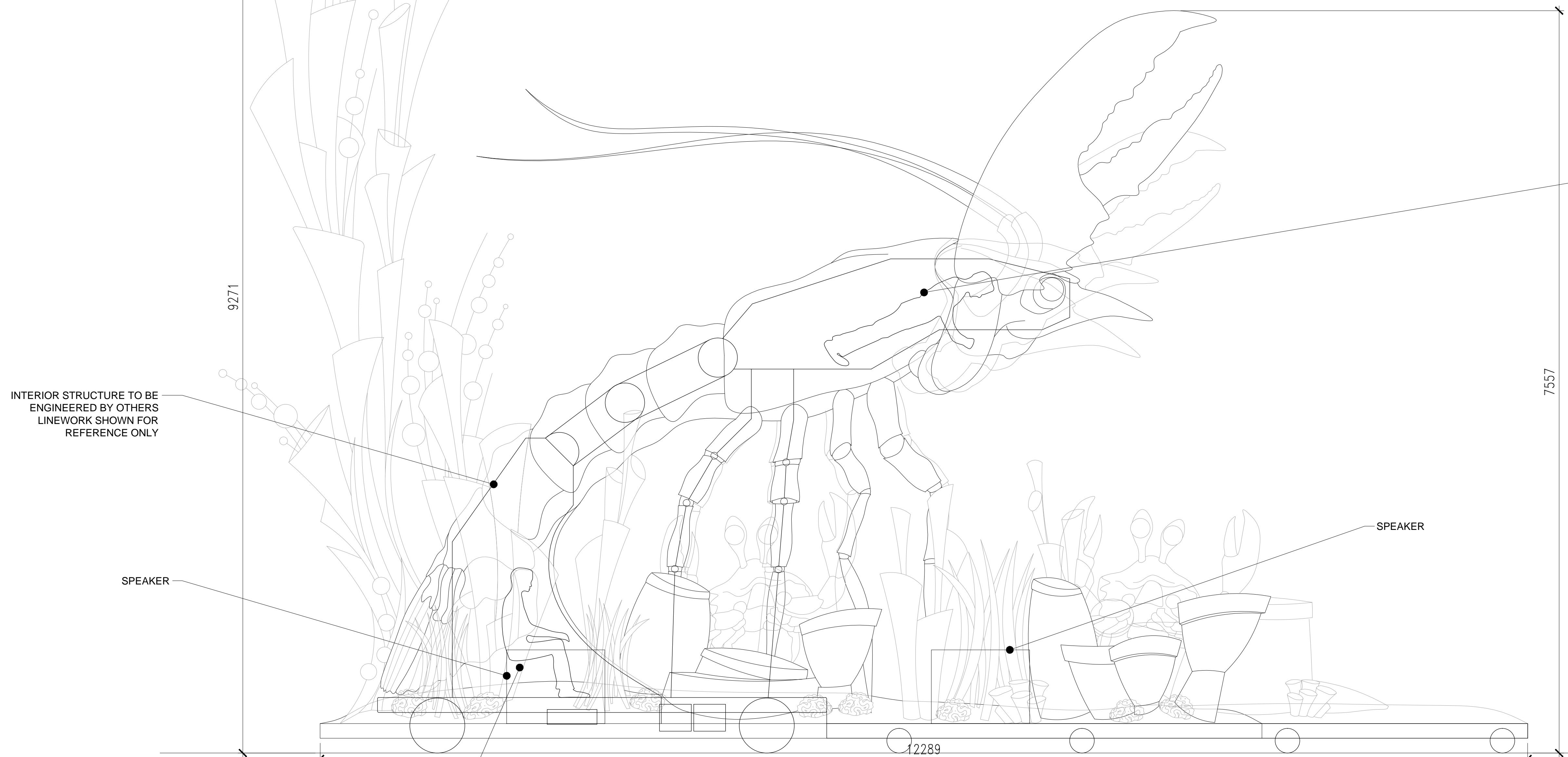

3 CHIMELONG PARADE CRUSTACEAN CARNIVAL PLAN
 1:50



NOT FOR
 CONSTRUCTION

INTERIOR STRUCTURE TO BE ENGINEERED BY OTHERS LINEWORK SHOWN FOR REFERENCE ONLY

DRIVER SEAT AND LOCATION TBD BY OTHERS

PUPPETEER LOCATION MECHANISM TO BE ENGINEERED BY OTHERS

NUMBER	ANIMATION or EFFECT	DESCRIPTION OF ANIMATION OR EFFECT	QUANTITY
F2-A	ANIMATION	BODY - Whale "swims" in tipping motion - mechanical	1
F2-B.1	EFFECT	BLOW HOLE CONFETTI - whale blow hole blasts Mylar flutter-fetti	1
F2-B.2	EFFECT	BLOW HOLE LN2 - blow hole blasts LN2 in between confetti blasts	1
F2-C	ANIMATION	EYELIDS - eyelids open/ close on timer - mechanical	2
F2-D	ANIMATION	EYES - eyes left/ right on timer - mechanical	2
F2-E	ANIMATION	TAIL - tail fin left/ right, up/down - mechanical	1
F2-F	EFFECT	LIGHTS - twinkling LED lights chase through livery	AS NEEDED
F2-G	ANIMATION	FLIPPERS - swimming animation - mechanical	1

ISSUE DATE	DESCRIPTION
2012/09/10	CONCEPT DESIGN
11-OCT-2012	CONCEPT DEVELOPMENT
-	-
-	-
-	-



CONCEPT ARTWORK

INTERIOR STRUCTURE TO BE ENGINEERED BY OTHERS LINEWORK SHOWN FOR REFERENCE ONLY
BENCH AND SAFETY EQUIPMENT FOR GUESTS TO BE DESIGNED AND PROVIDED BY OTHERS

INTERIOR STRUCTURE TO BE ENGINEERED BY OTHERS LINEWORK SHOWN FOR REFERENCE ONLY

EXTENT OF WHALE MOTION
ADDITIONAL TAIL MOTION SHOWN ON SHEET D-F2-02

FLEXIBLE "SKIN" AND "COSTUME" TO ALLOW FOR TAIL MOTION

F2-E EXTENT OF WHALE MOTION
ADDITIONAL TAIL MOTION SHOWN ON SHEET D-F2-02

"PAGODA" TO BE DESIGNED TO COLLAPSE DOWN BELOW 9 METER HEIGHT BY OTHERS

F2-F LED LIGHTS

TAIL STRUCTURE AND MECHANISM TO BE ENGINEERED BY OTHERS

FLEXIBLE "SKIN" AND "COSTUME" TO ALLOW FOR TAIL MOTION

F2-G FLIPPERS

PAINTED "WAVES"

PROP FISH

F2-A WHALE BODY PIVOT POINT

INTERIOR STRUCTURE TO BE ENGINEERED BY OTHERS LINEWORK SHOWN FOR REFERENCE ONLY

SADDLE FOR COSTUMED PERFORMER w/UMBRELLA

BLOW HOLE
F2-B.1 SPARKLING CONFETTI EFFECT
F2-B.2 LN2 SMOKE

EXTENT OF WHALE MOTION

F2-C EYELIDS
(QUANTITY : 2)

F2-D ANIMATED EYES
(QUANTITY : 2)

EXTENT OF WHALE MOTION

DRIVER SEAT LOCATION TO BE DETERMINED

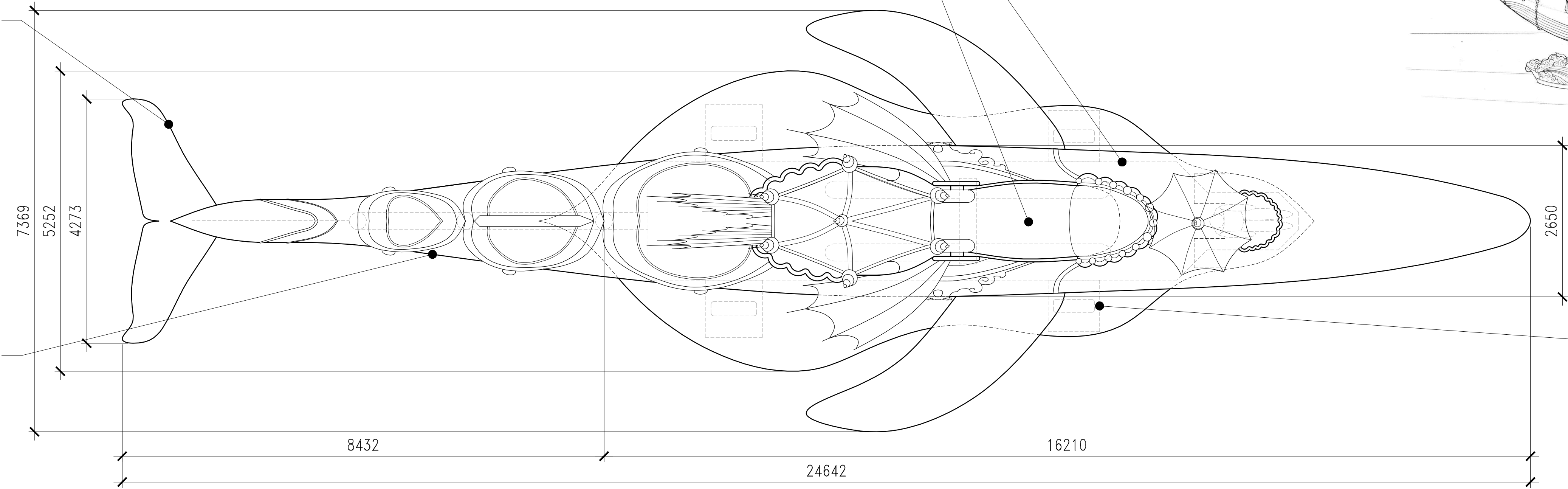

1 CHIMELONG PARADE THE GREAT WHALE PLAN
1:50

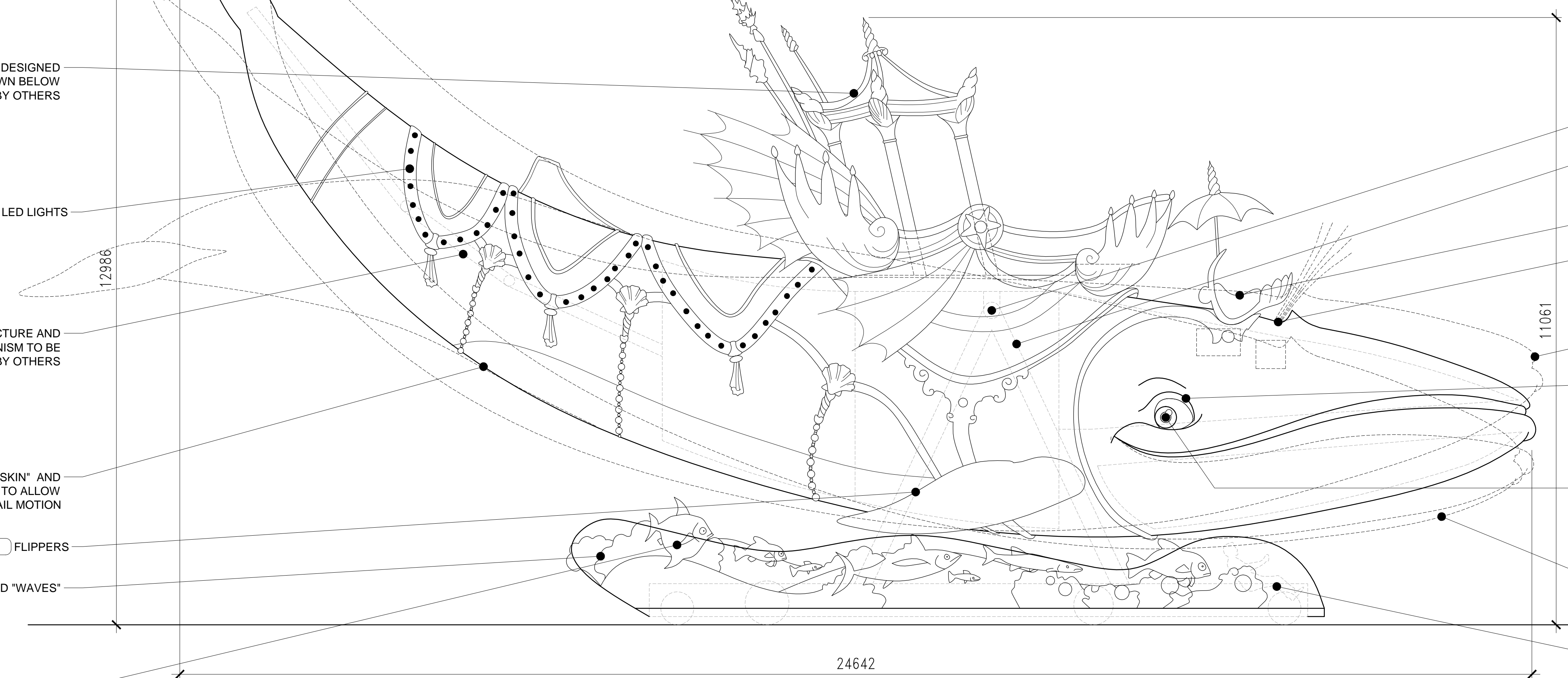

2 CHIMELONG PARADE THE GREAT WHALE ELEVATION
1:50

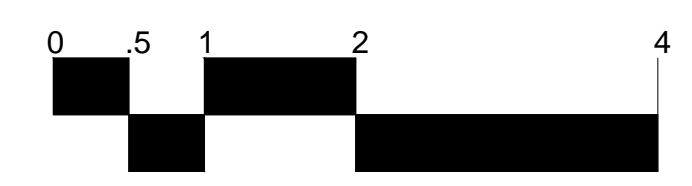

NOT FOR CONSTRUCTION

PROJECT:

HENQIN OCEAN KINGDOM

CLIENT:

Zhuhai Chimelong Investment and Development Co., Ltd.
 Chimelong Office G1,
 Fuxiang Bay, Hengqin New District
 Zhuhai 519031, People's Republic of China

CONSULTANT:

NOTICES:
 THESE PARADE DESIGN DOCUMENTS ARE FOR DESIGN INTENT PURPOSE ONLY AND NOT FOR CONSTRUCTION.

ANY PROJECT ARCHITECTURAL DESIGN, ENGINEERING, CONSTRUCTION, COMMISSIONING, AND COMPLIANCE WITH LOCAL LIFE SAFETY AND BUILDING CODES SHALL BE PROVIDED AND PERFORMED BY LOCALLY LICENSED PROFESSIONALS.

THE DATA IN THIS DOCUMENT INCORPORATE PROPRIETARY RIGHTS OF THE HETEMA GROUP, 67 VALLEY STREET PASADENA, CA 91105. ANY PARTY ACCEPTING THIS DOCUMENT DOES SO IN CONFIDENCE AND AGREES THAT IT SHALL NOT BE DUPLICATED, IN WHOLE OR IN PART, OR BE DISCLOSED TO OTHERS, WITHOUT THE PRIOR WRITTEN CONSENT OF THE HETEMA GROUP, INC. AND ZHUHAI CHIMELONG INVESTMENT AND DEVELOPMENT CO., LTD. CHIMELONG OFFICE G1, FUXIANG BAY, HENQIN NEW DISTRICT, ZHUHAI 519031, PEOPLE'S REPUBLIC OF CHINA

FINAL DESIGN
 PACKAGE UPDATE
 PROGRESS PLOT

ISSUE DATE	DESCRIPTION
2012/09/10	CONCEPT DESIGN
11-OCT-2012	CONCEPT DEVELOPMENT
-	-
-	-
-	-

DRAWING TITLE:
 CHIMELONG PARADE
 CONCEPT DEVELOPMENT
 THE GREAT WHALE

SHEET NO.

D-F2-02

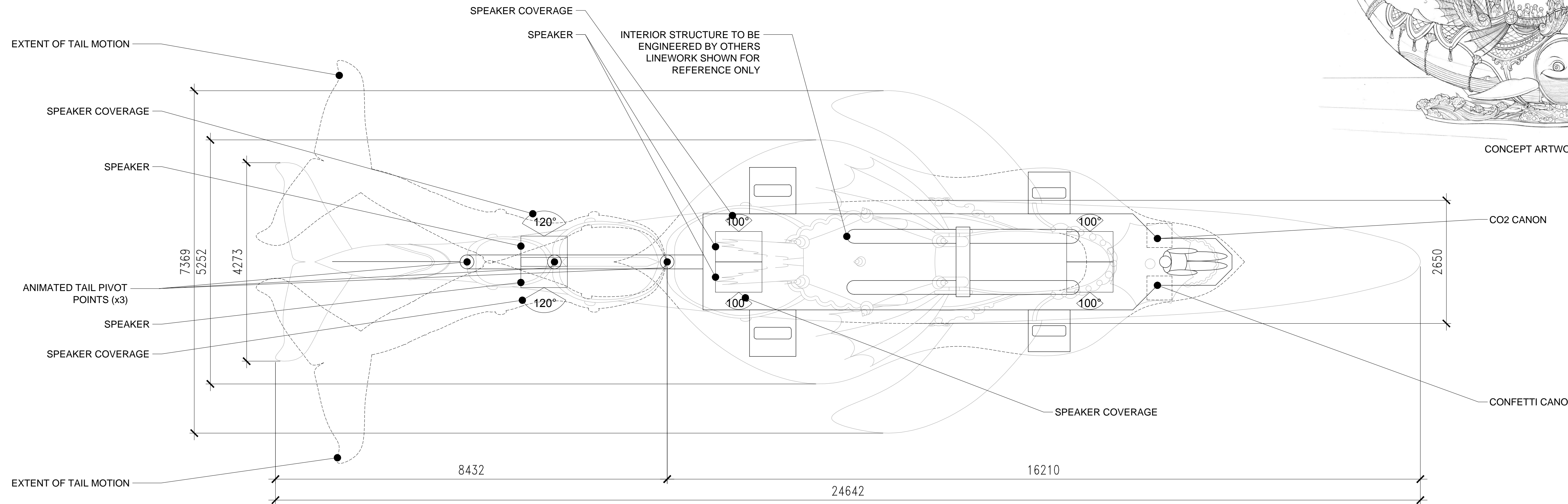

4 CHIMELONG PARADE THE GREAT WHALE PLAN
 1:50

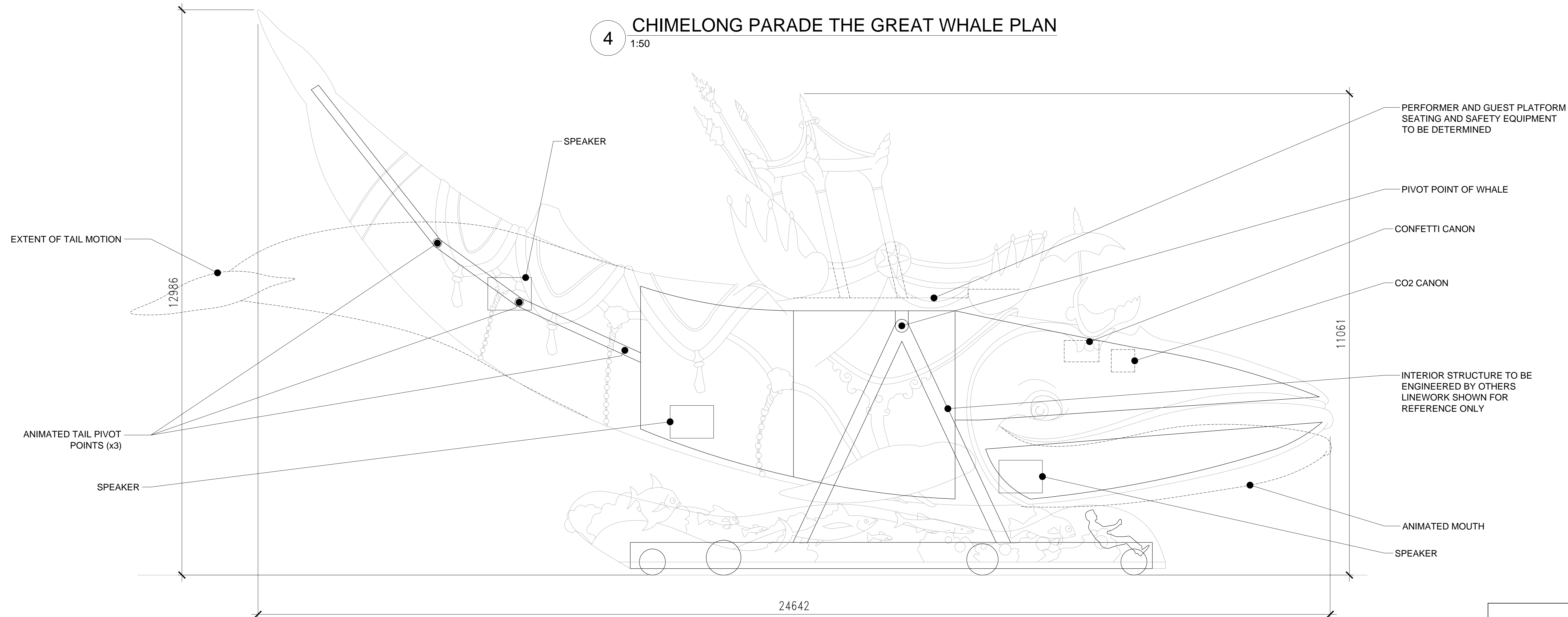

3 CHIMELONG PARADE THE GREAT WHALE ELEVATION
 1:50

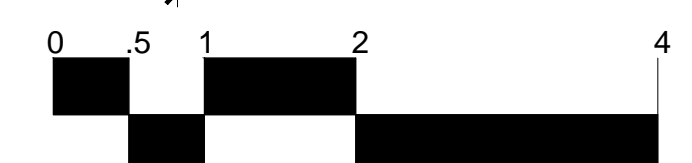

NOT FOR
 CONSTRUCTION